



Electromagnetic Simulation Techniques for Connectors and PCBs

Bill McGinn

Ansys Sr. Application Engineer



ANSYS is the Simulation Leader

FOCUSED

This is all we do.
Leading product technologies in all physics areas
Largest development team focused on simulation



CAPABLE



PROVEN

Recognized as one of the world's MOST INNOVATIVE
AND FASTEST-GROWING COMPANIES*

TRUSTED

96 of the top 100

FORTUNE 500 Industrials
ISO 9001 and NQA-1 certified



INDEPENDENT

Long-term financial stability
CAD agnostic





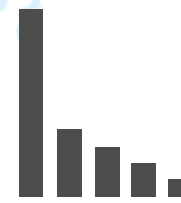



LARGEST

3x The size of our
nearest competitor

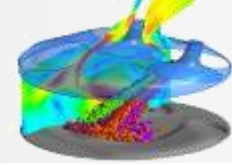

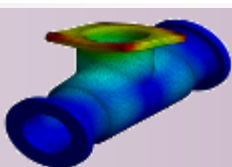
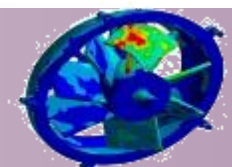
*BusinessWeek, FORTUNE

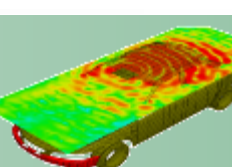
Breadth of Technologies

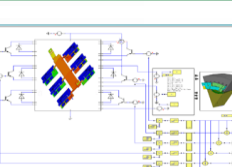
	Fluid Mechanics: From Single-Phase Flows		To Multiphase Combustion	
	Structural Mechanics: From Linear Statics		To High-Speed Impact	
	Electromagnetics: From Low-Frequency Windings		To High-Frequency Field Analysis	
	Systems: From Data Sharing		To Multi-Domain System Analysis	

Summary

- Brief Overview of EM Techniques FEM and Transient
- Connector on Board “Assembly” Simulation
- HFSS 3D Components
- Thermal Simulation of EM Models
- EMI Analysis using HFSS
- EMI Scanner

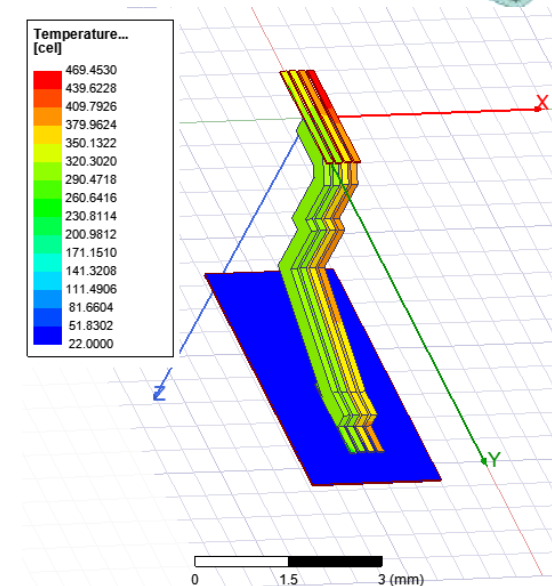
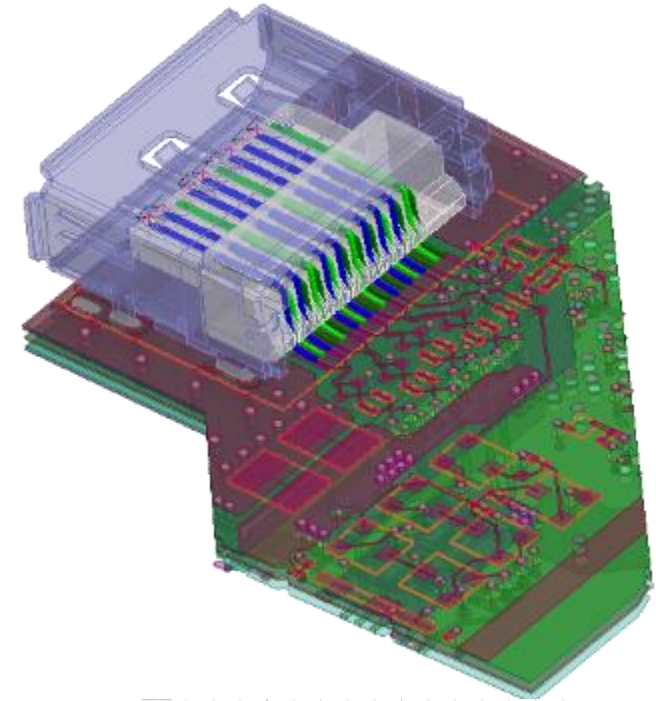

AEDT: ANSYS Electronics Desktop

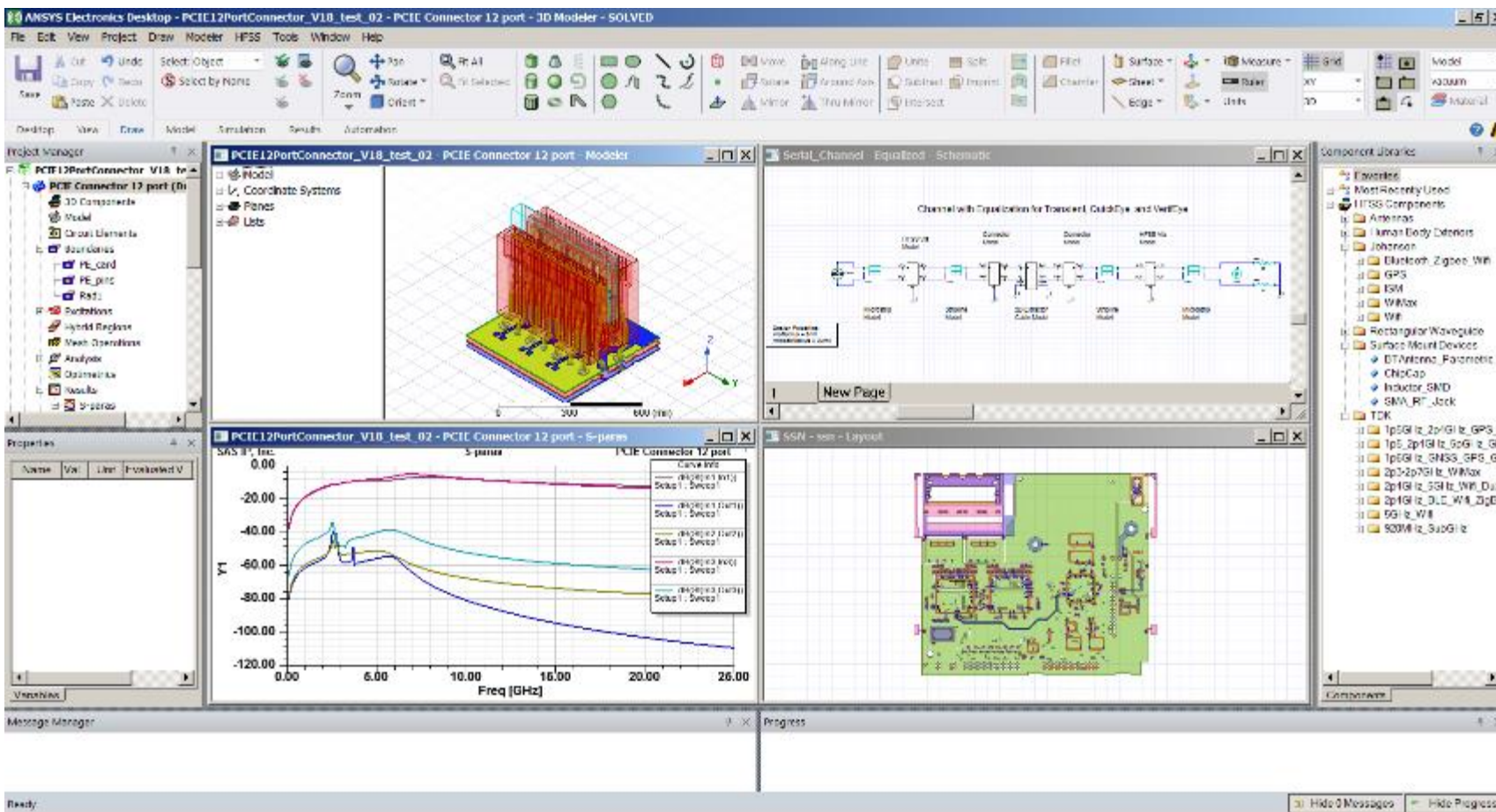

Single Desktop for:

- HFSS
- HFSS 3D Layout
- Circuit
- Thermal
- ...
- **Tight integration between circuit and 3D EM simulation**

HFSS: High Frequency Structure Simulator

- Full-wave FEM 3D electromagnetic field solver
 - Computes electromagnetic behavior of high-frequency and high-speed components and systems
 - Extracts S-, Y-, and Z-parameters
 - Provides 3D electromagnetic fields
- Applications
 - RF/Microwave
 - Biomedical
 - Radiation: Antennas, EMI/EMC
 - Signal Integrity/High Speed Digital
 - Packages
 - PCB
 - Connectors
 - Transitions

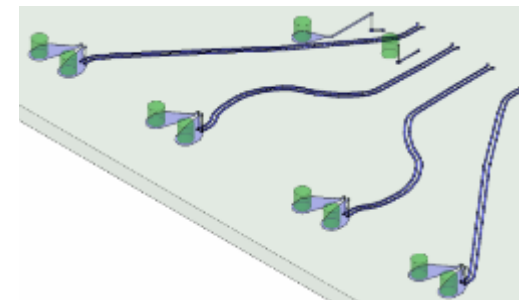
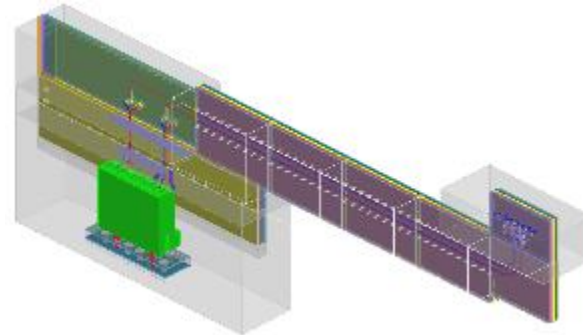
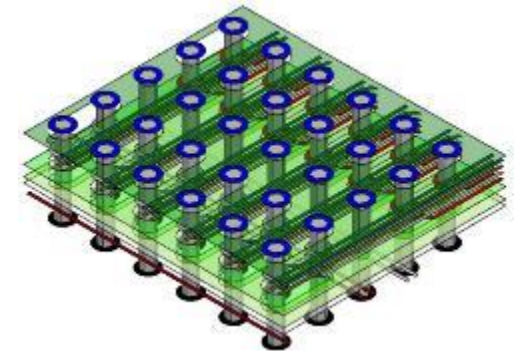
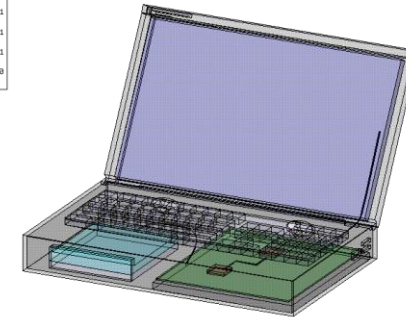
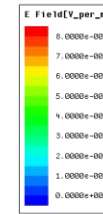
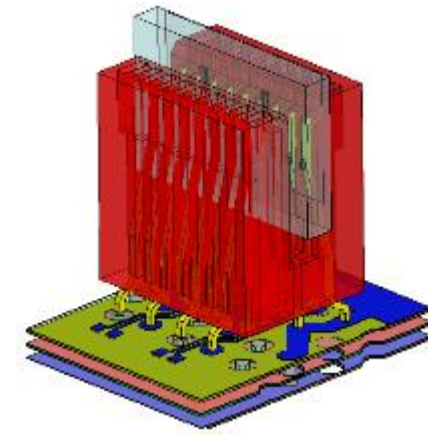

HFSS Transient Now Included with HFSS

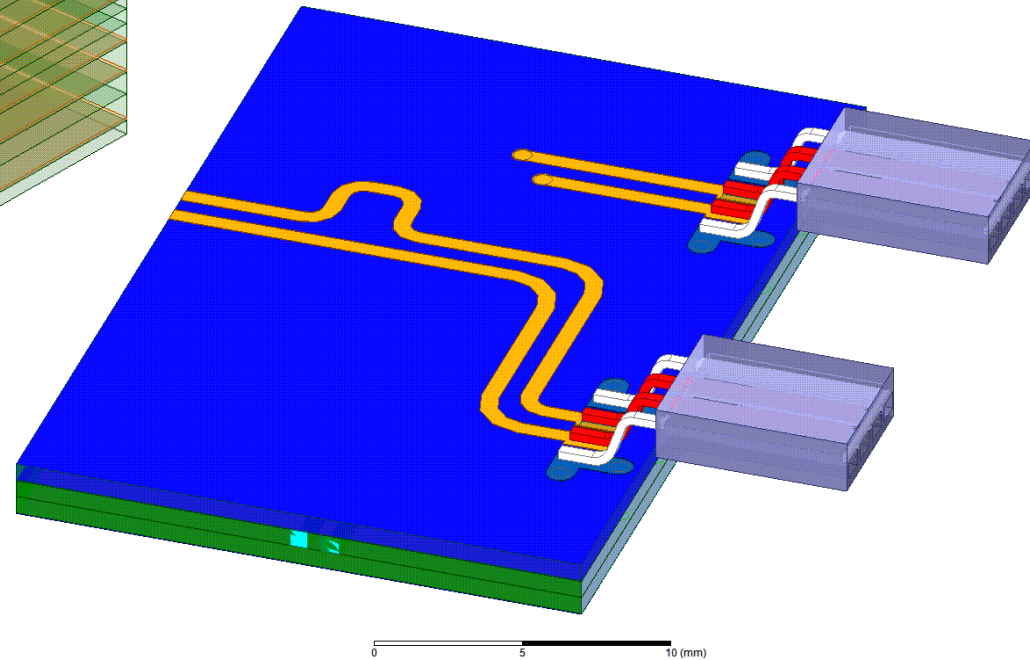
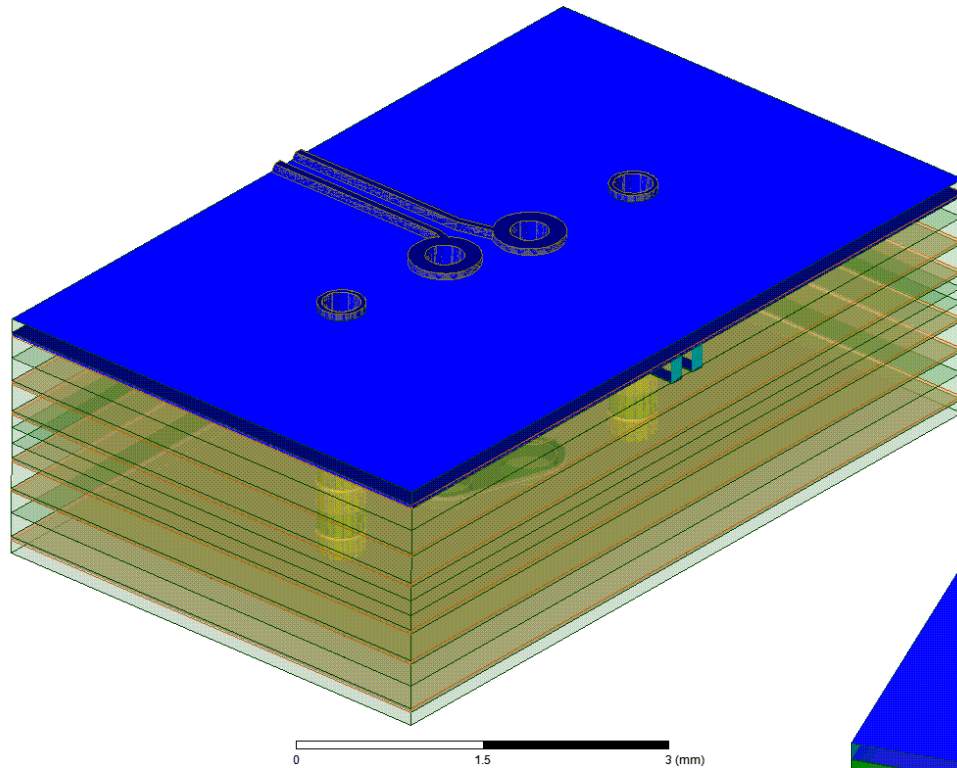

- **Time Domain Finite element solver**
- Faster implicit solver (New 2019)
- Improved Auto-HPC performance (New 2019)
- Unstructured FEM Mesh based on Tets (variable size, variable order, conformal)
- Adaptive meshing
- Local time stepping
- Waveform input flexibility (oblique angles)



HFSS 3D Layout

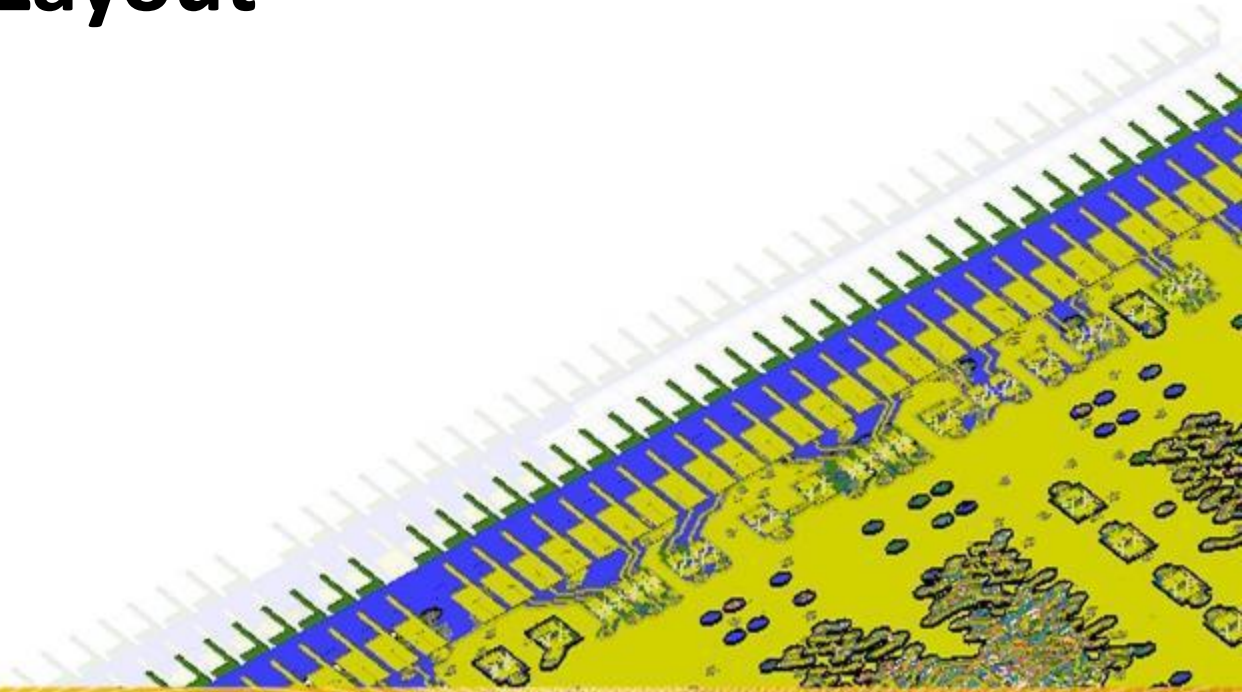

HFSS: Arbitrary 3D Geometry Editor

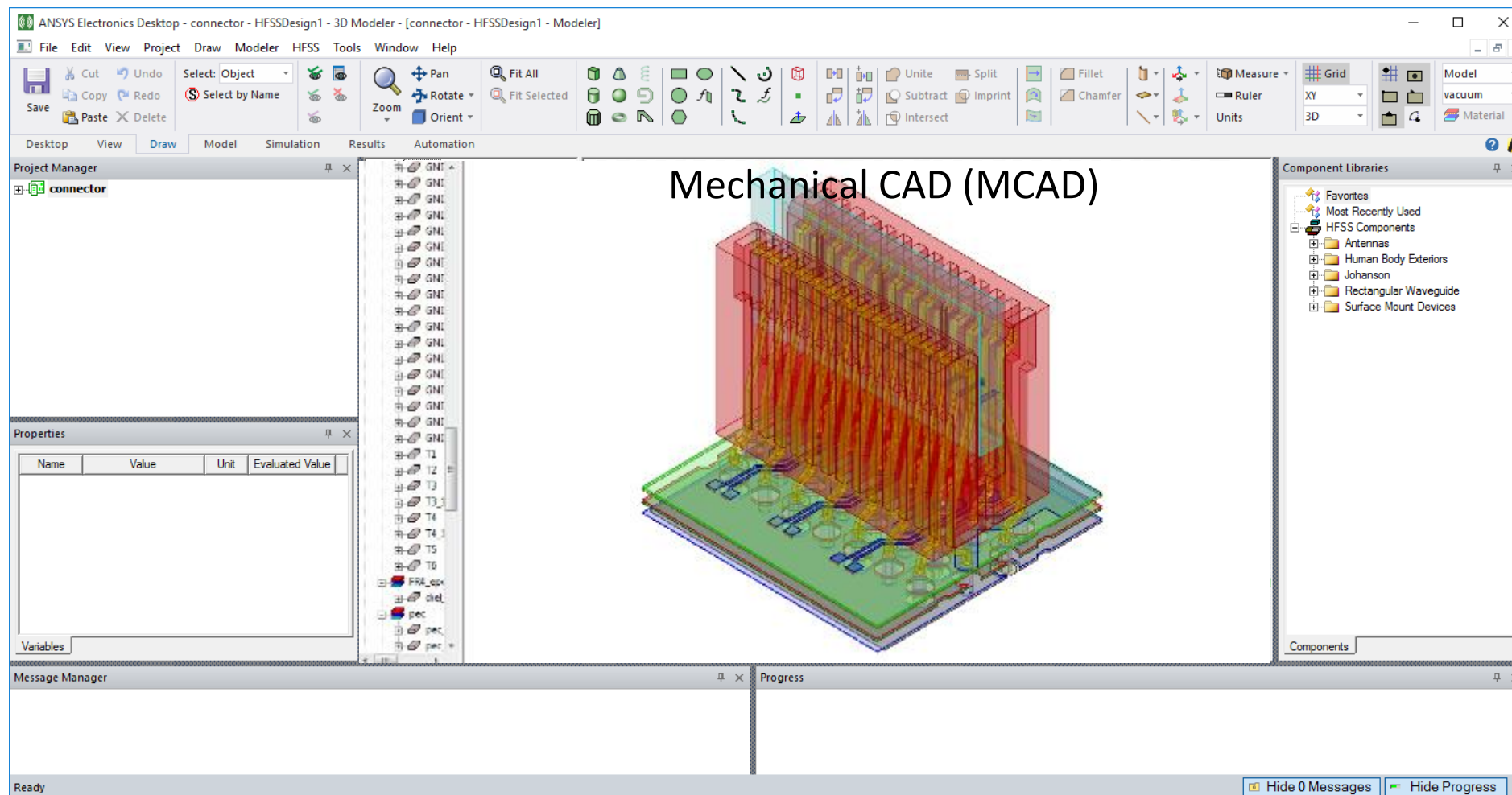

HFSS 3D Layout Desktop

Menu bar

Tool bar

Project Manager

Layout Editor

Nets Window

Layers Window

Property Window

Components Window

Message Manager

Progress Window

The screenshot displays the ANSYS Electronics Desktop interface for HFSS 3D Layout. The central workspace shows a 3D isometric view of a PCB layout with various components and traces. The interface includes a menu bar at the top with options like File, Edit, View, Project, Draw, Layout, HFSS 3D Layout, Tools, Window, and Help. Below the menu bar is a tool bar with icons for Save, Copy, Paste, Undo, Redo, and various simulation and analysis tools. On the left side, the Project Manager tree shows the project structure, including PCB_2019R1 and Galileo_G87173_204. The Properties window at the bottom left shows a table with columns for Name, Val, Unit, and Evaluated V, with fields for Setup, Enable, Solver, Pass, Percent, Delta S, Solution, Basis, Max Ref, Use Ma, and Solver T. On the right side, the Nets Window lists various nets like GND, USBH0_DN, and VBUS1. The Layers Window shows a grid of checkboxes for different layers and regions. The Components Window displays a list of components like IP0201-121 and Galileo_G87173_204. The Message Manager at the bottom shows the current project path. The Progress Window at the bottom right shows the simulation progress. The status bar at the very bottom displays coordinates and units.

Name	Val	Unit	Evaluated V
Setup	HF		
Enable	<input checked="" type="checkbox"/>		
Solver	HF		
Pass			
Percent	30		
Delta S	0.02		
Solution	2	GHz	
Basis Or	Mix		
Max Ref	100		
Use Ma	<input type="checkbox"/>		
Solver T	Dr		

Stackup Editor : Manufacturing Tolerances

Stackup - Layer

Display:
 Stackup layer
 Non-stackup layer
 All layers

Stackup:
 Laminated mode
 Unit: mm

Color	Visible	Name	Type	Material	Dielectric P1	Thickness	Etch	Rough	Solver	Transparency
Orange	<input checked="" type="checkbox"/>	UNNAMED_000	dielectro	Al		0.01	<input checked="" type="checkbox"/>	<input type="checkbox"/>	<input type="checkbox"/>	BD
Blue	<input checked="" type="checkbox"/>	TOP	signal	COPPER	Al	1.5mil	<input checked="" type="checkbox"/>	<input type="checkbox"/>	<input type="checkbox"/>	BD
Green	<input checked="" type="checkbox"/>	UNNAMED_002	dielectro	Nelco N4000-13 SI (In)	Nelco N4000-13 SI (In)	5mil	<input type="checkbox"/>	<input type="checkbox"/>	<input type="checkbox"/>	BD
Red	<input checked="" type="checkbox"/>	LAYER2	signal	COPPER		1.4mil	<input type="checkbox"/>	<input type="checkbox"/>	<input type="checkbox"/>	BD
Light Blue	<input checked="" type="checkbox"/>	UNNAMED_004	dielectro	Nelco N4000-13 SI (In)	Nelco N4000-13 SI (In)	49.4mil	<input type="checkbox"/>	<input type="checkbox"/>	<input type="checkbox"/>	BD
Light Green	<input checked="" type="checkbox"/>	LAYER3	signal	COPPER		1.4mil	<input type="checkbox"/>	<input type="checkbox"/>	<input type="checkbox"/>	BD
Light Purple	<input checked="" type="checkbox"/>	UNNAMED_006	dielectro	Nelco N4000-13 SI (In)	Nelco N4000-13 SI (In)	0.01	<input type="checkbox"/>	<input type="checkbox"/>	<input type="checkbox"/>	BD
Light Blue	<input checked="" type="checkbox"/>	BOTTOM	signal	COPPER	Al	1.5mil	<input type="checkbox"/>	<input type="checkbox"/>	<input type="checkbox"/>	BD
Light Green	<input checked="" type="checkbox"/>	UNNAMED_008	dielectro	Al		0.01	<input type="checkbox"/>	<input type="checkbox"/>	<input type="checkbox"/>	BD

Layers:
 Insert above...
 Insert below...
 Remove
 Select all

Etch selected:
 Name: TOP
 Type: signal
 Material: COPPER

Visibility:
 Visible
 Hidden

Attributes:
 Negative
 Rough

Etch:
 Etch: 0
 Rough
 Solver

HFSS Etch Factor

Layer: TOP
 Thickness: 4.8376e-005
 Etch factor: 0

Calculator
 Etch factor = layer thickness / (bottom - top) / 2
 Top dimension: 0.00019304
 Bottom dimension: 0.00019304

Etch top dimension
 Etch bottom dimension
 Top as percent of bottom: 100

HFSS Etch Factor

Layer: TOP
 Thickness: 4.8376e-005
 Etch factor: 2

Calculator
 Etch factor = layer thickness / (bottom - top) / 2
 Top dimension: 0.00014478
 Bottom dimension: 0.00019304

Etch top dimension
 Etch bottom dimension
 Top as percent of bottom: 75

HFSS Etch Factor

Layer: TOP
 Thickness: 4.8376e-005
 Etch factor: -2

Calculator
 Etch factor = layer thickness / (bottom - top) / 2
 Top dimension: 0.00019304
 Bottom dimension: 0.00014478

Etch top dimension
 Etch bottom dimension
 Bottom as percent of top: 75

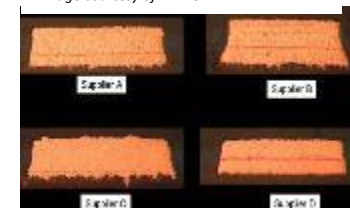
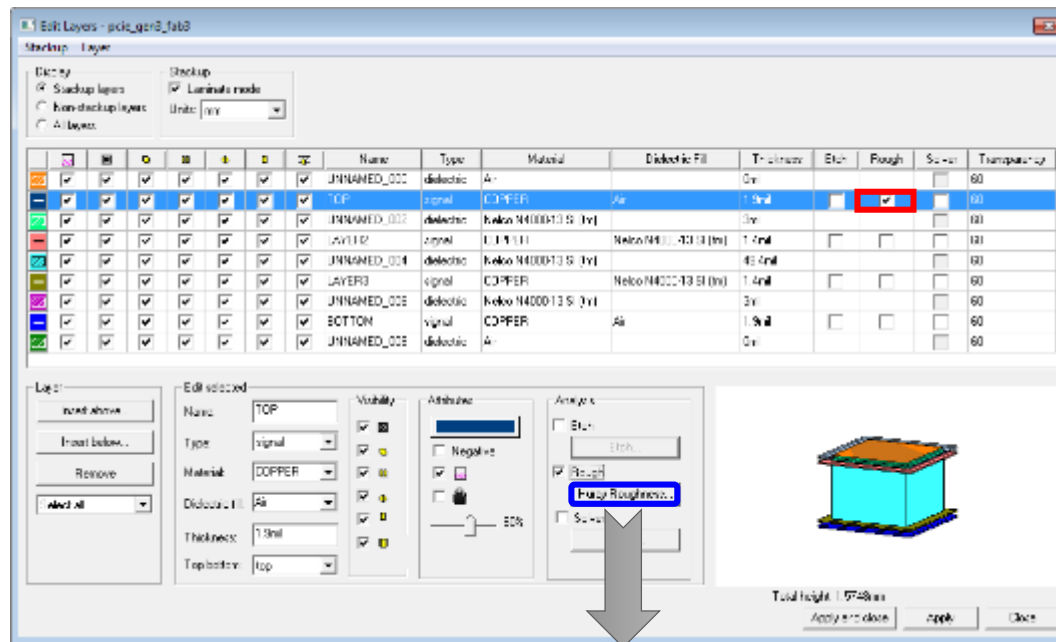

Image courtesy of AMKOR



Stackup Editor : Surface Roughness

- Surface Roughness
 - Huray or Grosse Roughness Models
 - Per Layer based
 - Per polygon based



Surface roughness

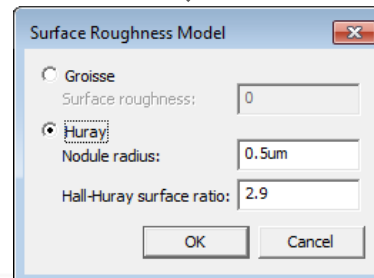

Power Loss due to Periodic Structures in High-Speed Packages and Printed Circuit Boards

Priya Pathmanathan^{1,2}, Christine Madden Jones^{3,4,5}, Steven G. Pytel^{1,2,3}, David L. Edgar⁴, and Paul G. Huray⁵

¹Intel Corporation, DuPont, Washington, 98327, USA
²University of South Carolina, Columbia, South Carolina, 29208, USA
³U.S. Navy, North Charleston, South Carolina, 29419, USA
⁴ANSYS Inc, Canonsburg, Pennsylvania, 29054, USA
⁵ANSYS UK Ltd, Beckwith, Berkshire, RG12 7BW, UK

Phone: +1 253 371 6265, E-mail: priya.pathmanathan@intel.com

Abstract

In this paper we apply the basic principles of electromagnetic wave propagation in periodic media to explain the

high-frequency power loss mechanisms of Printed Circuit Boards (PCBs) containing periodic structures. For this purpose we analyze the periodic media consisting of alternating layers of alternating periodic media in a typical PCB. We formulate distributed homogeneous regions and solve them to get the relations between the effective dielectric constants. The periodic structure media and find the dispersion relation and Bloch wave number (k) separately for TE and TM modes. k is purely real and where k becomes complex, which respectively. These modes result in resonant power loss. We validate this theory by creating a parameterized, full-wave using ANSYS HFSS™ and HFSS-Transient™ to reveal are clearly observed through the simulated parameters are well matched to theoretical predictions. Finally, power loss, frequency regimes in the design of high-speed

Keywords: Periodic Wave Propagation, Fiber Wave, H

Introduction

Man-made materials often consist of periodically placed structures and substances. Starting from late Nineteenth century, scientists [1] analyzed the problem of wave propagation in periodic lattices. Periodic wave propagation theory was exploited in designing electrical filters in the form of periodic networks, optical reflectors, beam splitters and polarizers in the form of stratified optical thin films. During the 1950s, periodic structures were heavily used in antenna engineering and Electronic Band Gap (EBG) structures. Frequency dependent propagation loss properties were well studied in the twentieth century with a focus on crystalline structures and Bragg diffraction. Leon Brillouin [2] studied periodic wave propagation in atomic structures and introduced the concept of Brillouin Zones. Since then, several researchers have analyzed electromagnetic and acoustic wave

DesignCon 2010

Impact of Copper Surface Texture on Loss: A Model that Works

Paul G. Huray, University of South Carolina,
huray@sc.edu

Olufemi(Femi) Oluwafemi, Intel Corporation,
olufemi.b.oluwafemi@intel.com

Jeff Loyer, Intel Corporation,
jeff.loyer@intel.com

Eric Bogatin, Bogatin Enterprises,
eric@BeTheSignal.com

Xiaoning Ye, Intel Corporation,
xiaoning.ye@intel.com

HFSS 3D Layout: “Connector-on-Board”

Combine ECAD (PCB, Package) and MCAD (Connector) in single design and simulation flow

Single 3D Mesh

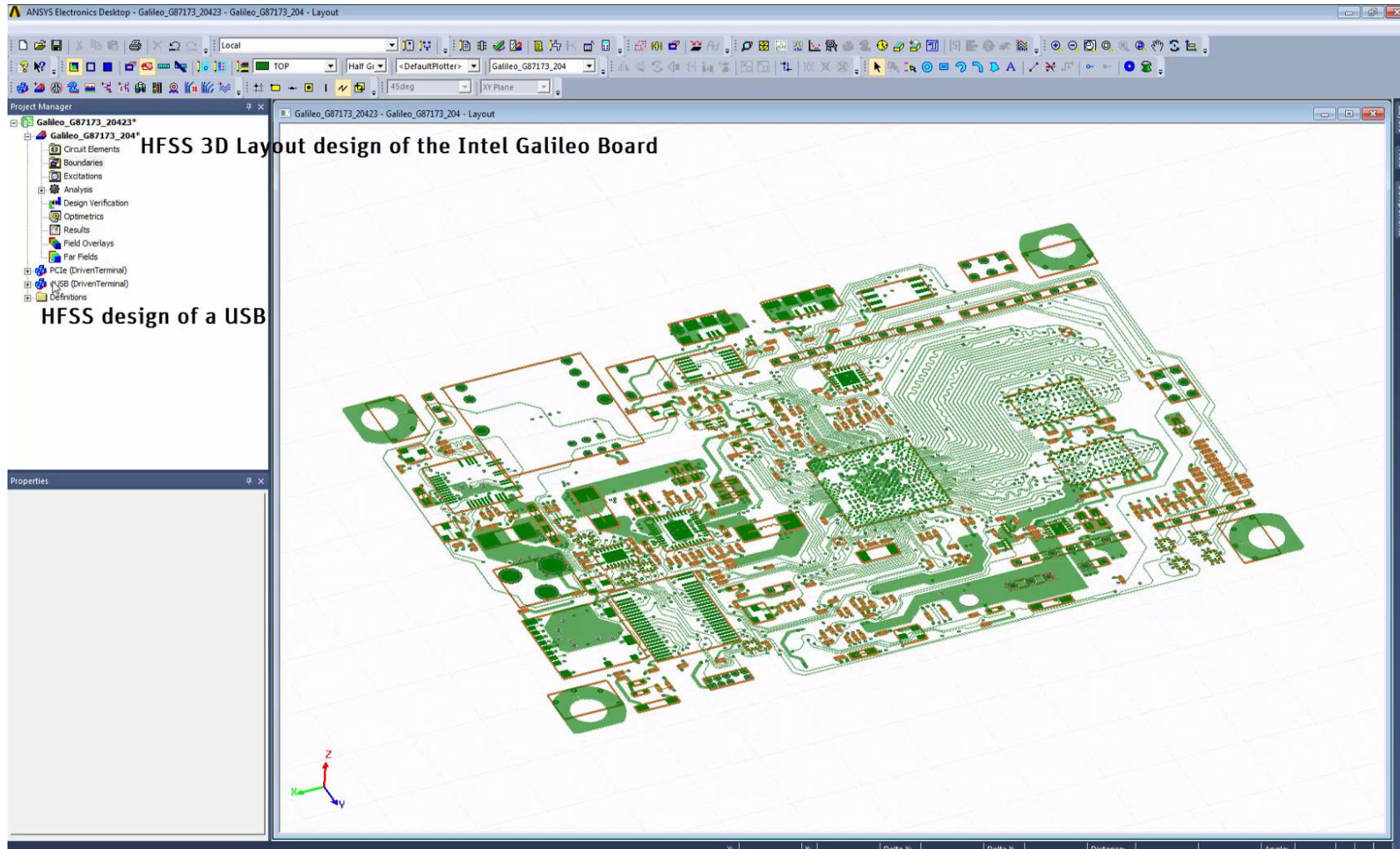

System Analysis within HFSS 3D Layout

Assemble ECAD & MCAD

- Select appropriate solver
 - HFSS or **Siwave**
- Connect TX/RX up within Schematic
 - LNA
 - IBIS & IBIS-AMI
 - QuickEye, VerifEye
 - HSPICE*
 - PSPICE**

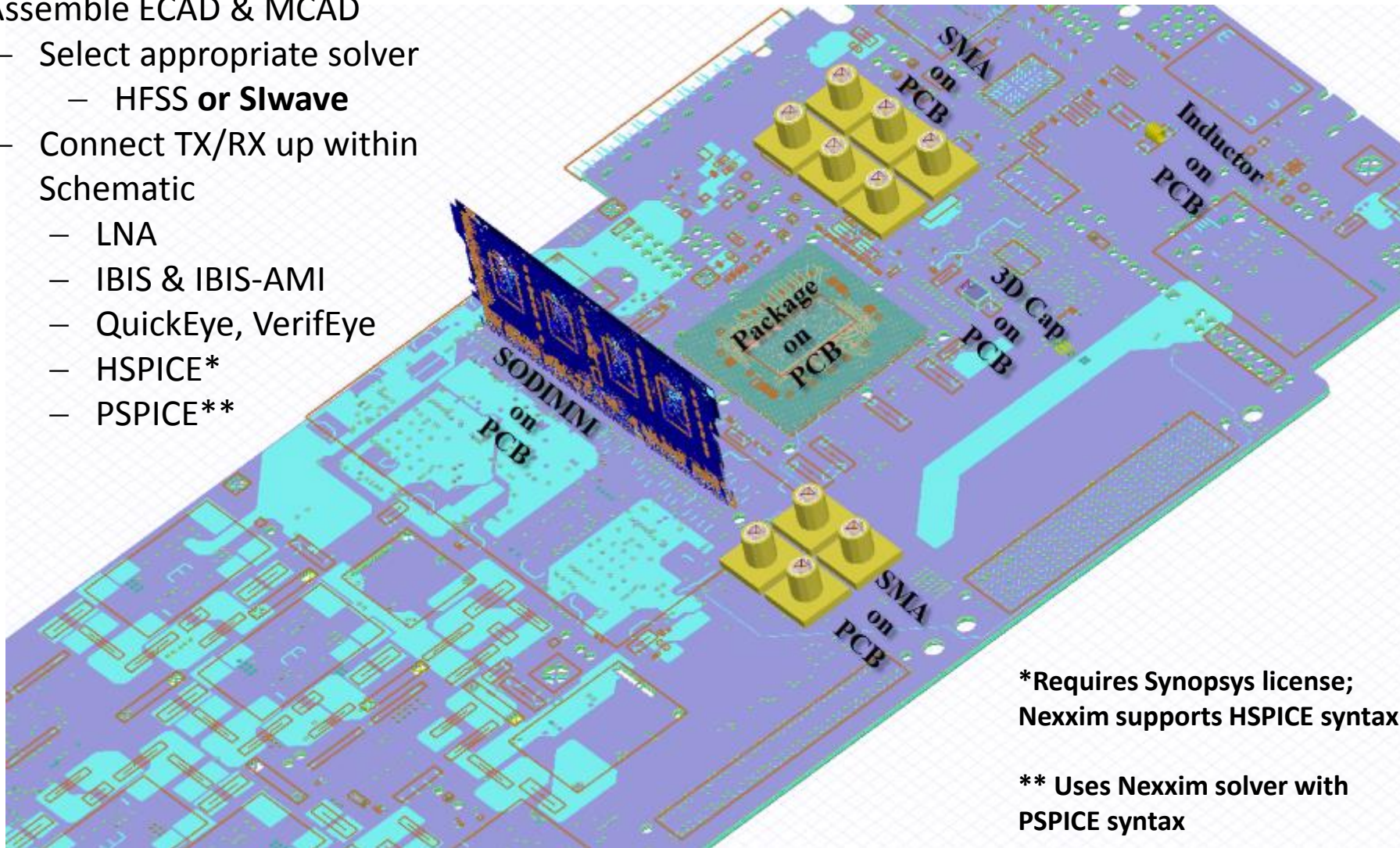

*Requires Synopsys license;
Nexxim supports HSPICE syntax

** Uses Nexxim solver with
PSPICE syntax

3D Layout Capabilities and Performance

- MCAD Utilizes “TAU” Mesher
- ECAD Utilizes “PHI” Mesher
- New ECAD+MCAD mesh assembly process
 - Phi is used when appropriate
 - Material overrides supported
 - Parallel ECAD meshing
 - Faster mesh generation
- Numerical de-embedding of non-rectangular lumped ports

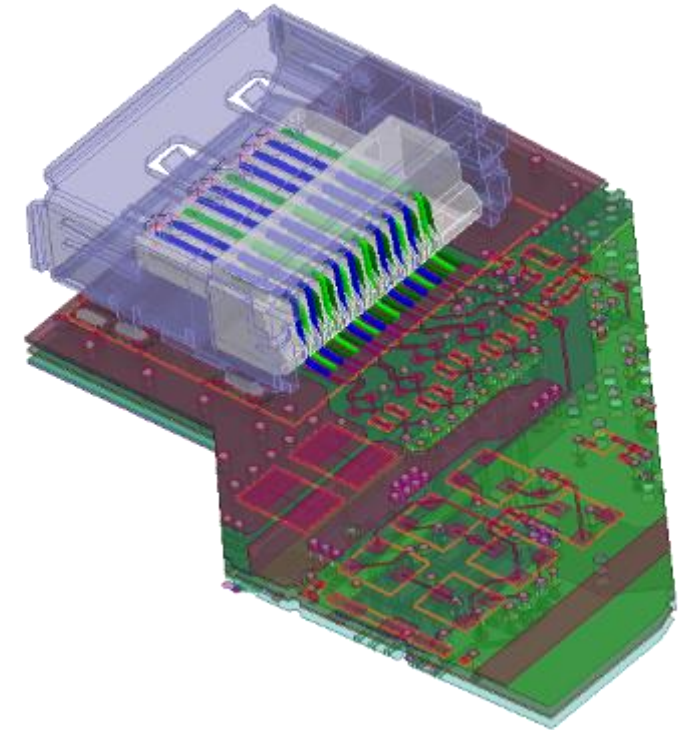
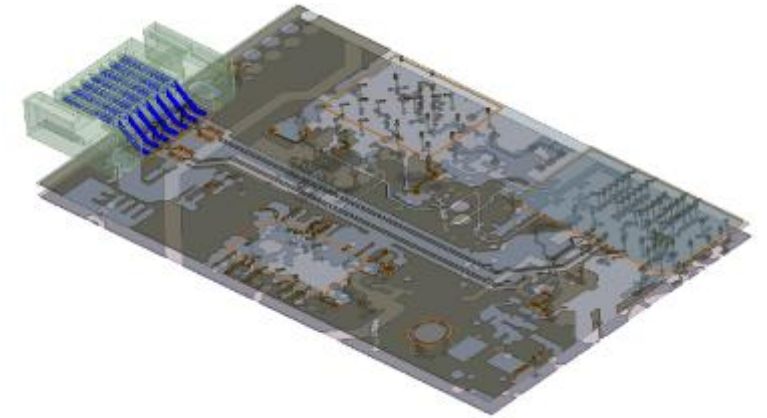

New: Full Assembly - ECAD + MCAD Mesh Assembly

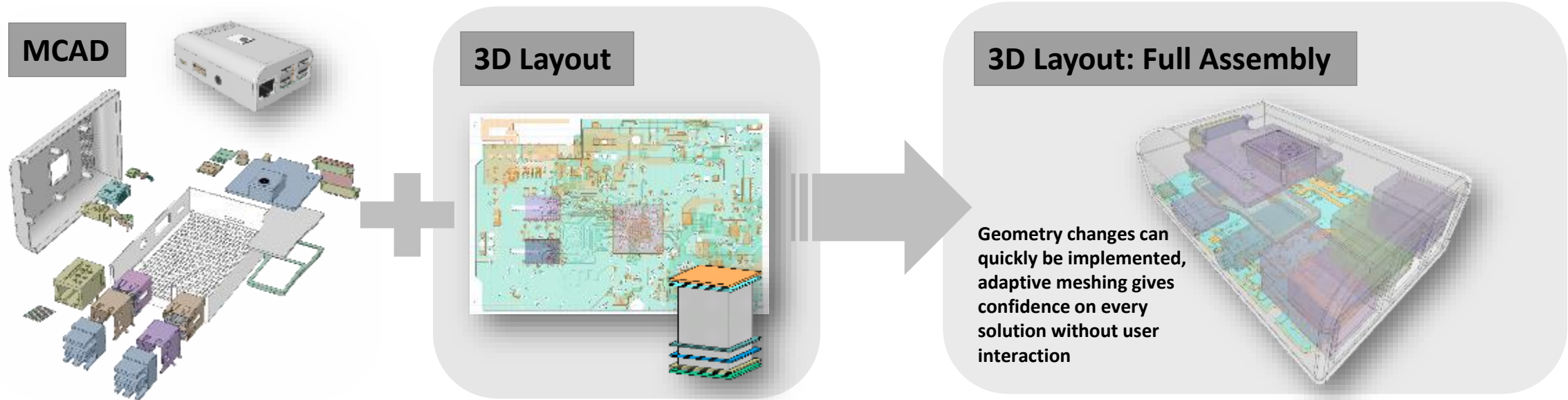

EDT HFSS Simulation

2D Cross section of mesh

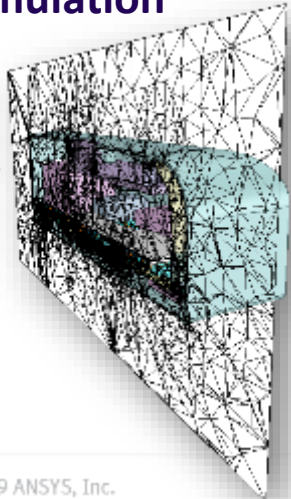

Automatically generated mesh shown on PCB

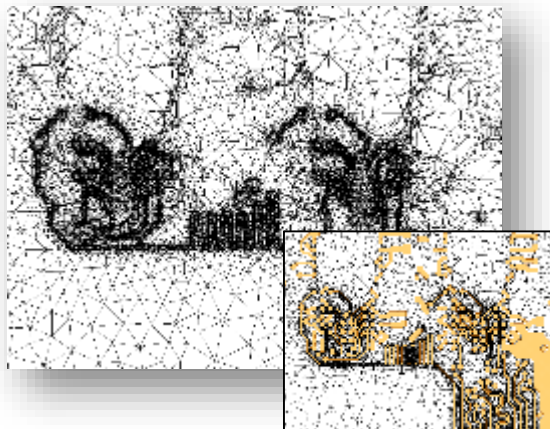

- **Automated Mesh Creation**
 - Accurate
 - Efficient
- **Solve time independent of port count**
 - Capture full network parameters for all nets simultaneously with low computational overhead
- **Captures small and large features efficiently**
 - Small pitch traces, meandering traces, accurate coupling and isolation

Simulation Setup Example: Multi-die Laminate

- Assembly and meshing technology significantly speeds up simulation setup time
- 12 Filters, two SMD (as HFSS 3D Components), one Laminate

1. Component Creation via Scripted Automation – 7x faster

- 3D: 21m
- Layout w Mesh Assembly: 3m (Laminate/BAW + SMD)

2. Assembly Creation – 5x faster

- 3D: 9m + Validation (~13m)
- Layout w Mesh Assembly: 2m + Validation (<2m)

3. Project Opening – 5x faster

- 3D: 4m
- Layout w Mesh Assembly: 45s

4. Initial Mesh – 1.6x (~850k tets)

1. 3D: 1h9m
2. Layout w Mesh Assembly: 44m

5. Adaptive Mesh – 1.2x

1. 3D: 186m (144GB RAM)
2. Layout w Mesh Assembly: 156m

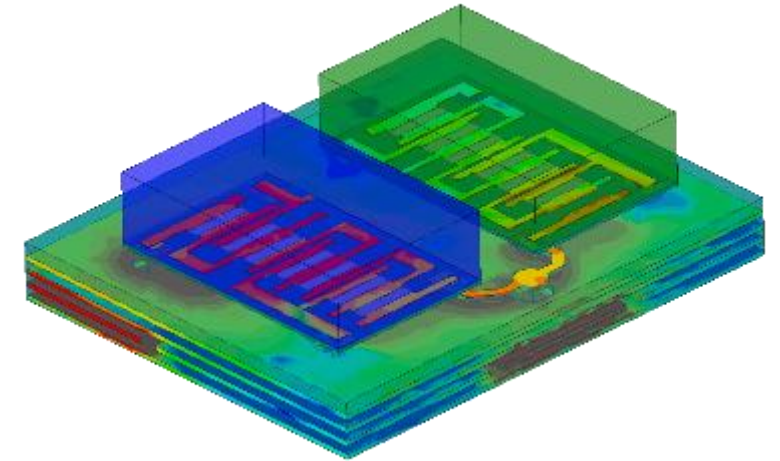

Representative design only

• 2019 R1 Flow Improvements

- HFSS Layout 3D with Mesh Assembly
 - Faster initial mesh time
 - Faster user experience
- Non-graphical Script Execution (Beta)
- Reduction in 3D Component size-on-disk
- Reduced 3D Validation Time

Electromagnetics Highlights

Integrated Transient Circuit Simulation

Assemble electronic system then perform electromagnetics plus transient circuit analysis system automatically

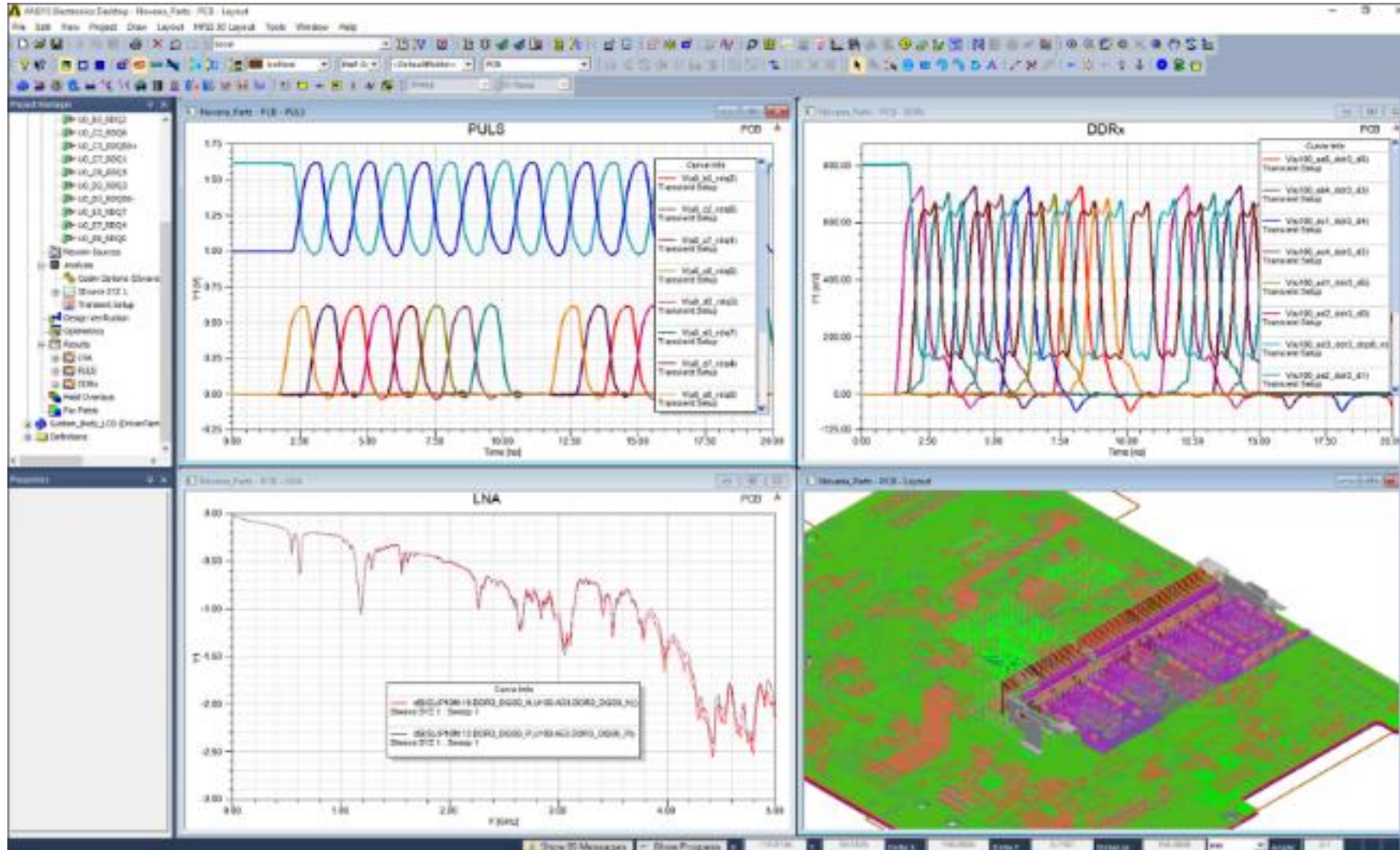

HFSS 3D Layout Improvements

- Far Field + Post-Processing Enhancements

- Consistent with HFSS 3D
- PML Support

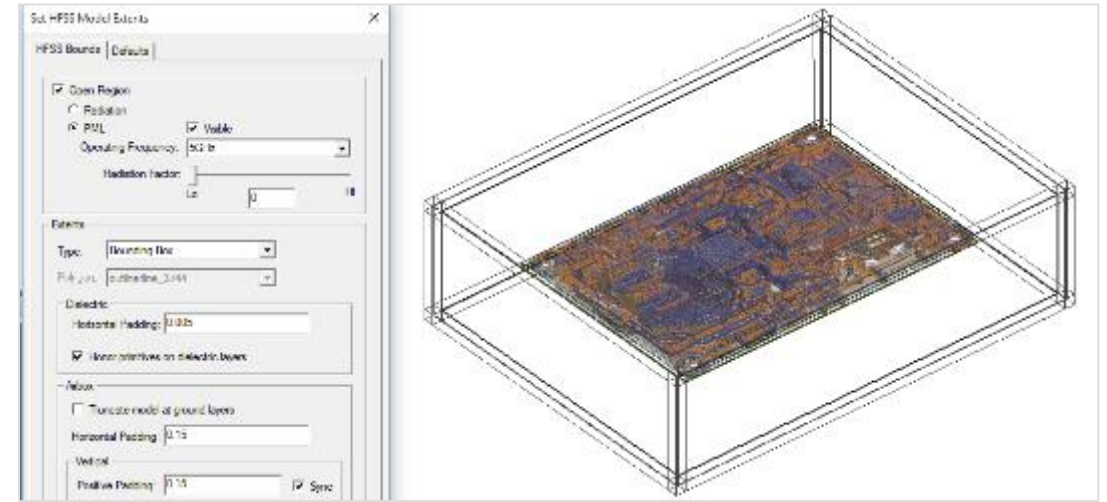

- Enhancements for on-chip inductor modeling

- Dielectric Stackup Simplification
- Via clustering

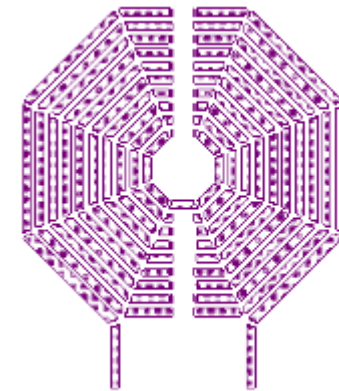
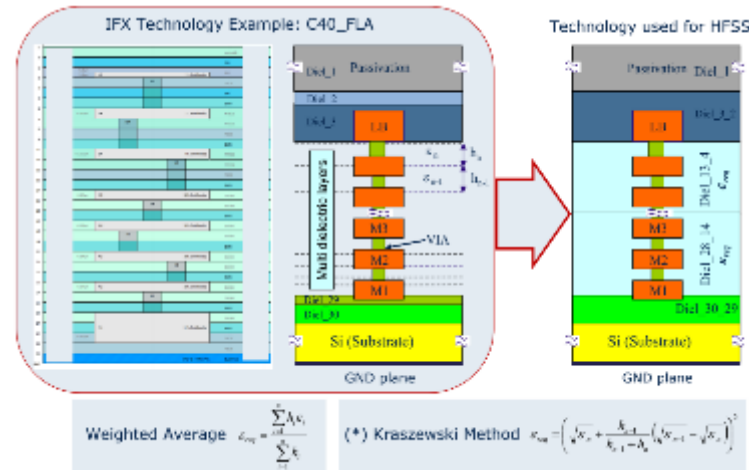

HFSS 3D Layout Port Configuration Enhancements

- Wave port support for mesh assembly
 - i.e. “connector-on-board”
- Usability improvements
 - Visualize wave port de-embed distance
 - Layer control for Pin-groups and internal/ref ports
 - Separate de-embedding/distance settings

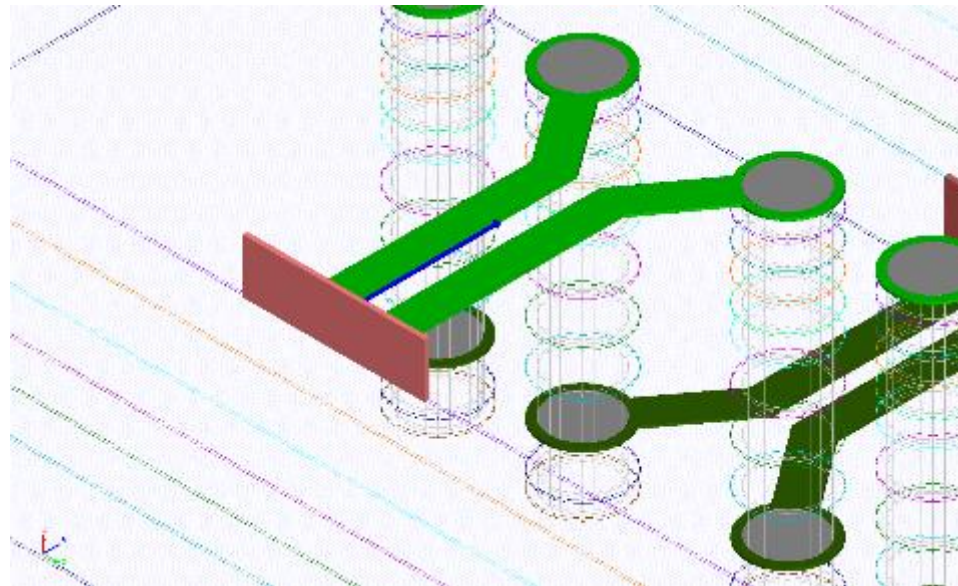
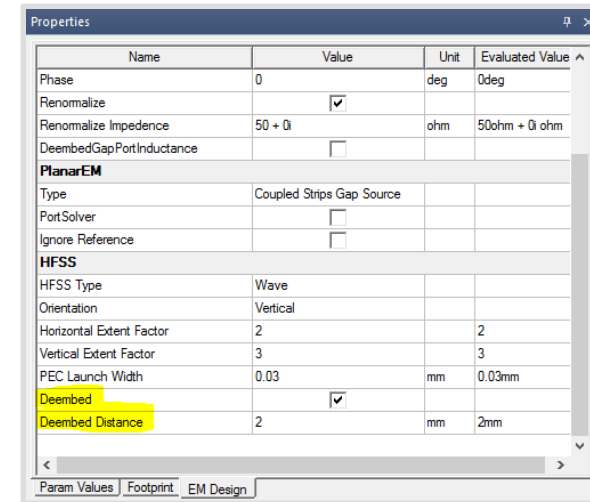

Stackup Wizard in 3D Layout Design

Layer Stackup Wizard

3D view controls
 Ignore layer thickness Show layer name

Units: mm No. of layers: 6

Layer spacing: Font size:

Trace width calculations
Selected layer name: SURFACE
Trace cross section: Rectangle

Frequency: 1GHz

Single Ended Nets Differential Nets

Required Z0(ohms): 50

Top ref layer name: None
Btm ref layer name: GND

Layer Name	Thickness	ID
UNNAMED_1	0mm	
SURFACE	0.03556mm	1
UNNAMED_1	0.127mm	
GND	0.03556mm	2
UNNAMED_1	0.4432mm	
PRE1	0.03556mm	
UNNAMED_1	0.127mm	
PRE1	0.03556mm	
UNNAMED_1	0.4432mm	
PRE1	0.03556mm	
UNNAMED_1	0.127mm	
PRE1	0.03556mm	
UNNAMED_1	0.4432mm	
PRE1	0.03556mm	

Compute width Apply Apply to all

Analysis
Trc width: 20: Compute Z0

Export W-element...
Reset View Close

- Quick selection of number/type of layers
- Single-ended & Differential trace synthesis & analysis
- Etch factor considered in trace computations
- Convenient 3D viewer

High Frequency Signal Integrity

- Single environment allows extraction of component models such as vias, connectors, and transmission lines as well as concatenating these and other models into a channel schematic
- S-parameters, eye diagrams, and bit error rate of channel can be simulated
- Individual components can be optimized and channel results updated quickly

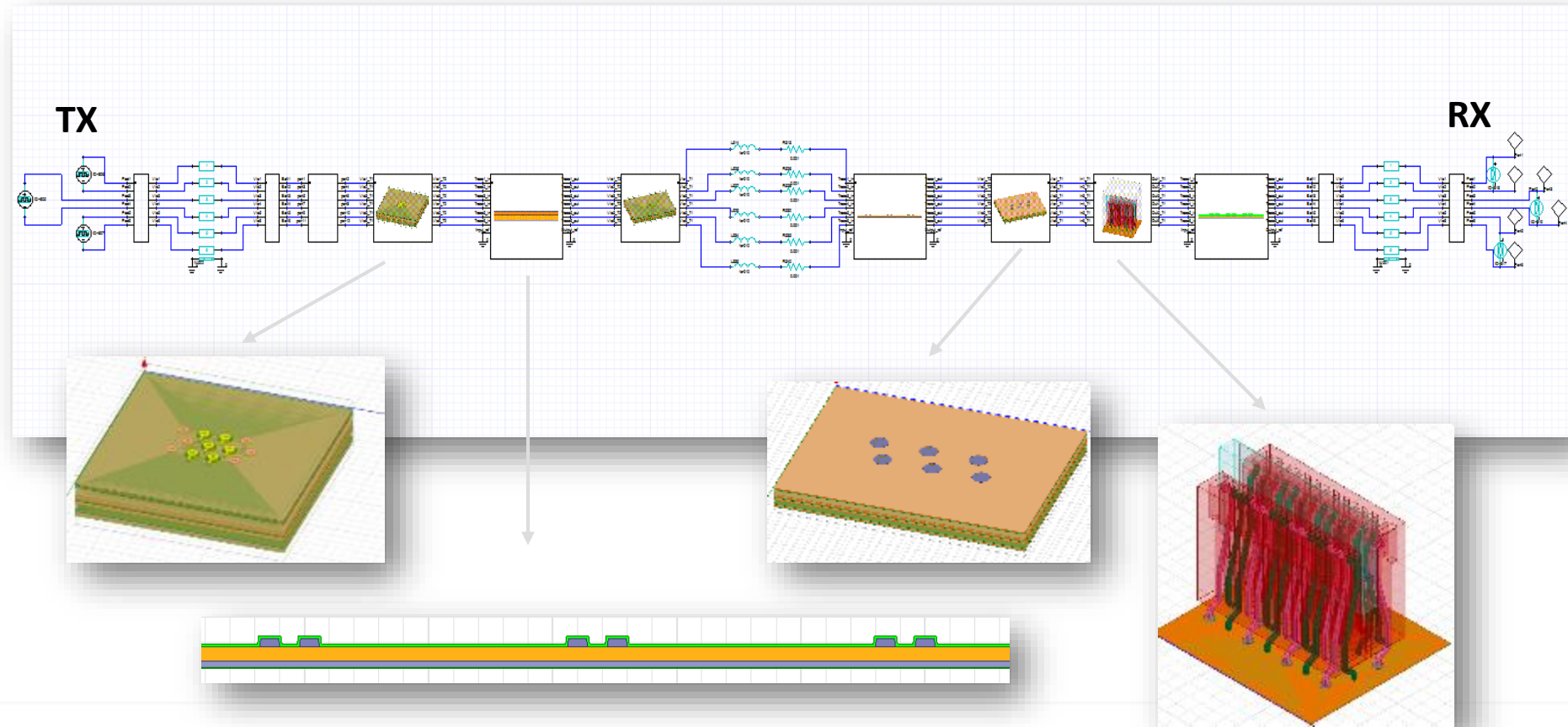



3D Components

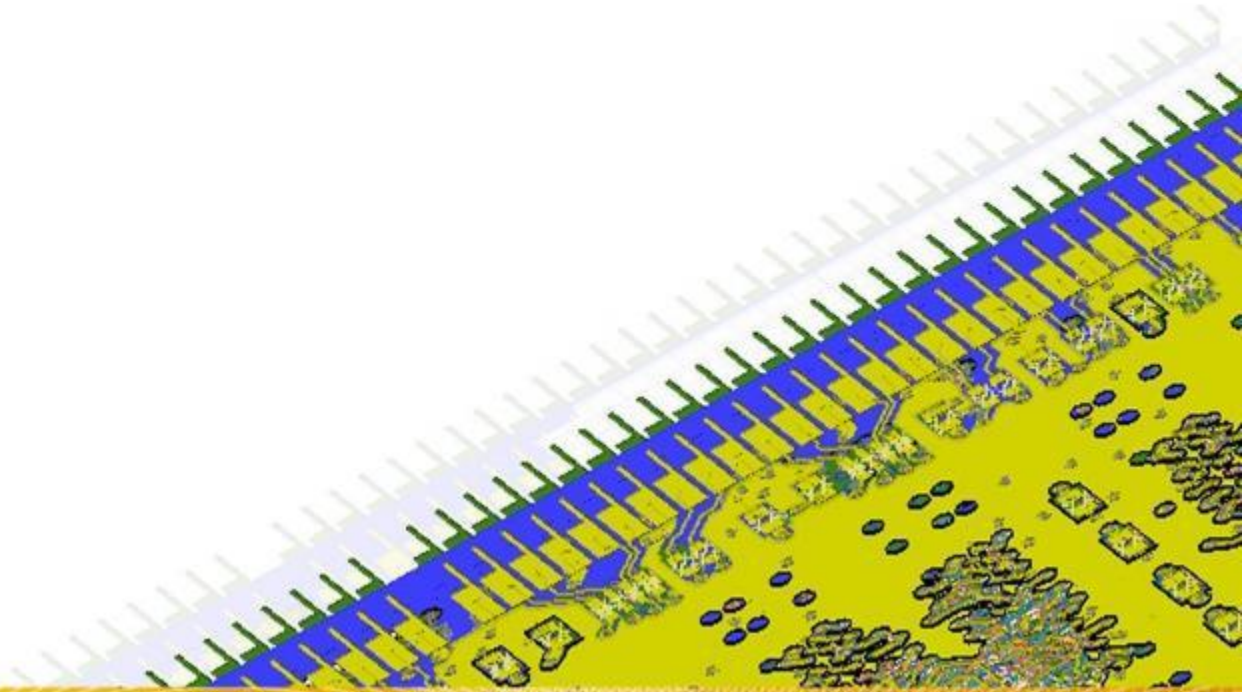

3D Components

- **3D Components**
 - Save and reuse designs
 - Share with partners, vendors and colleagues
- Contains
 - Geometries
 - Material properties
 - Boundary conditions
 - Excitations
 - Encryption

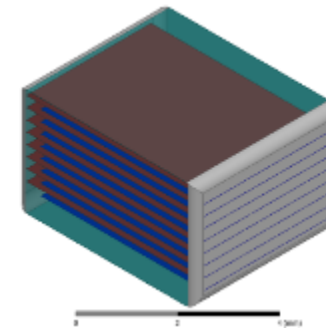
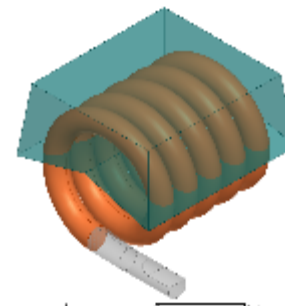
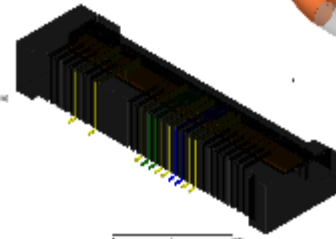
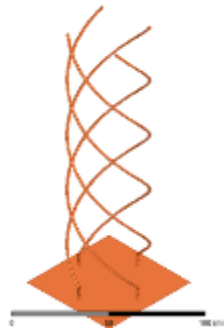
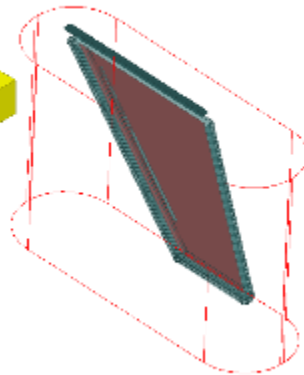
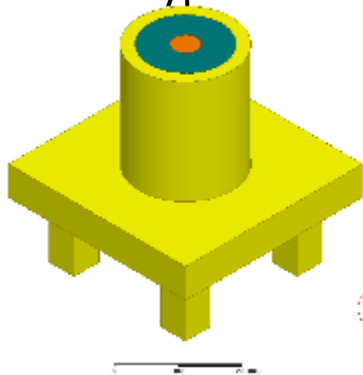
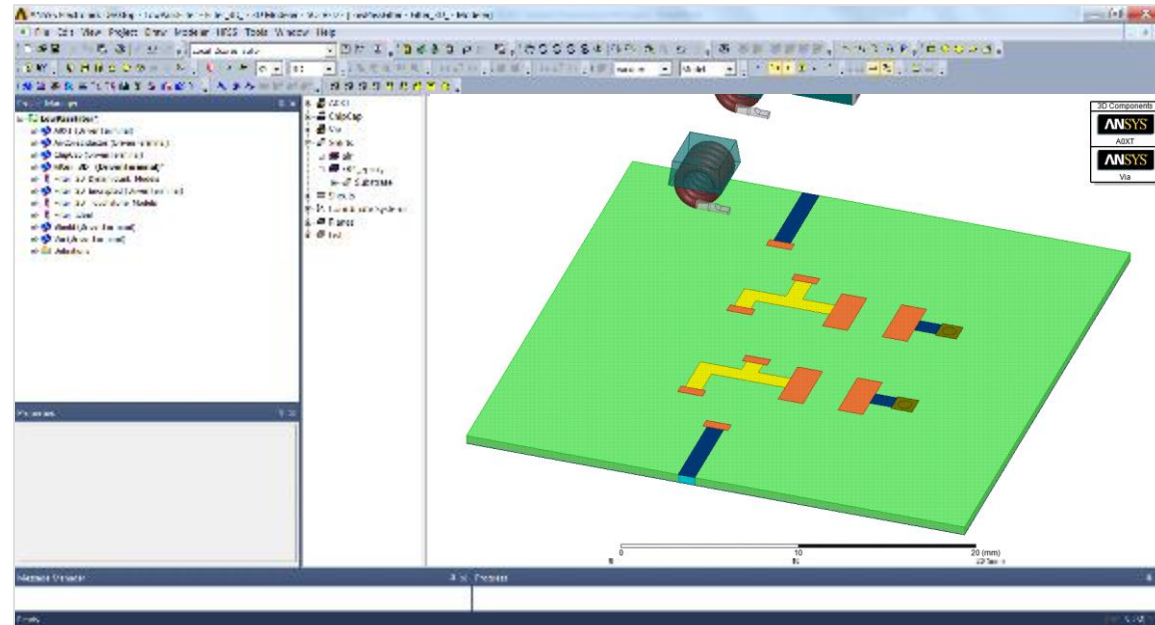

3D Components: Library Browser

- Easy availability of 3D Components
- Drag and drop of component geometry into modeler window

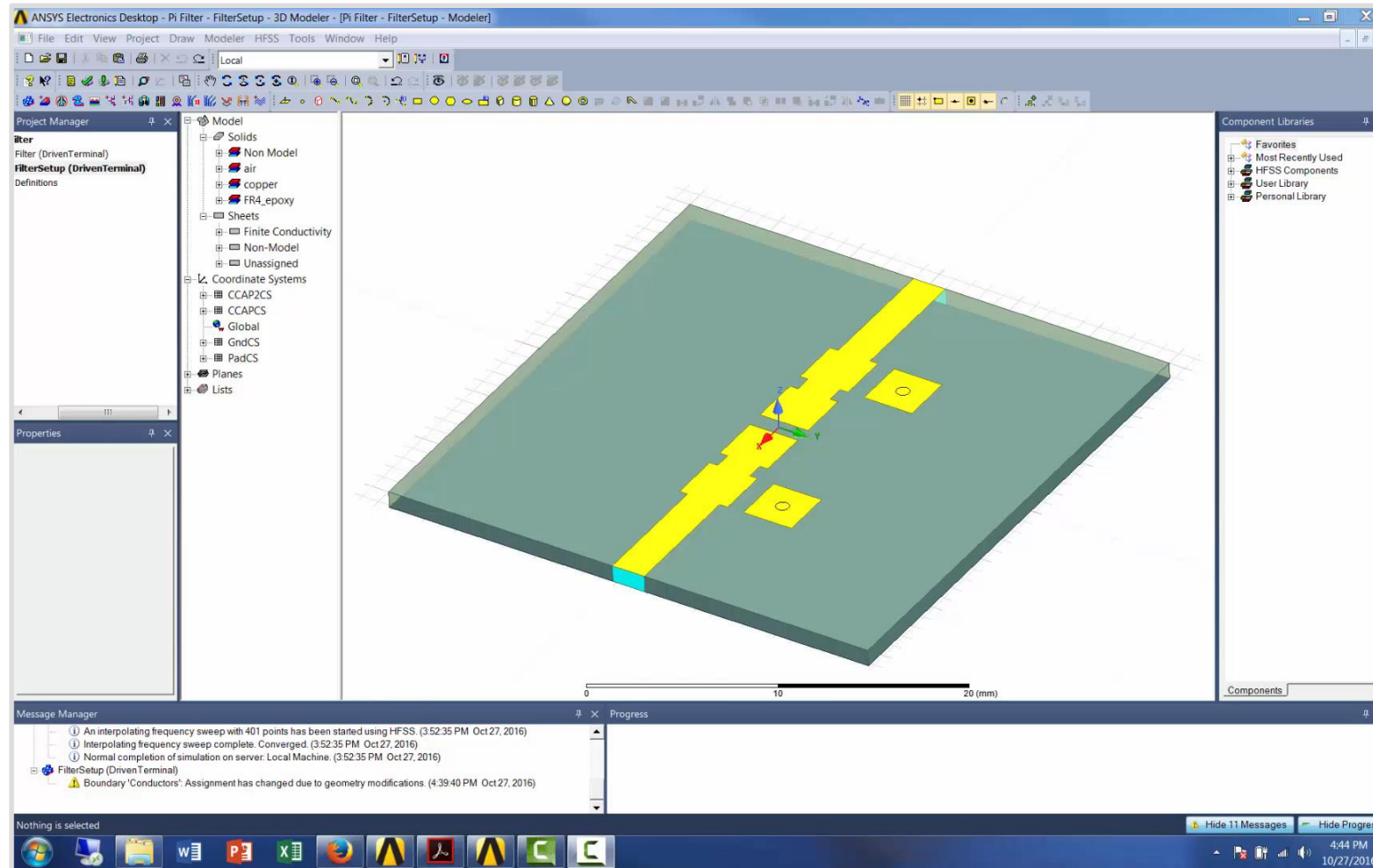

3D Component: Edit Definition

3D Component Edit

- An existing component can be flattened to a new design

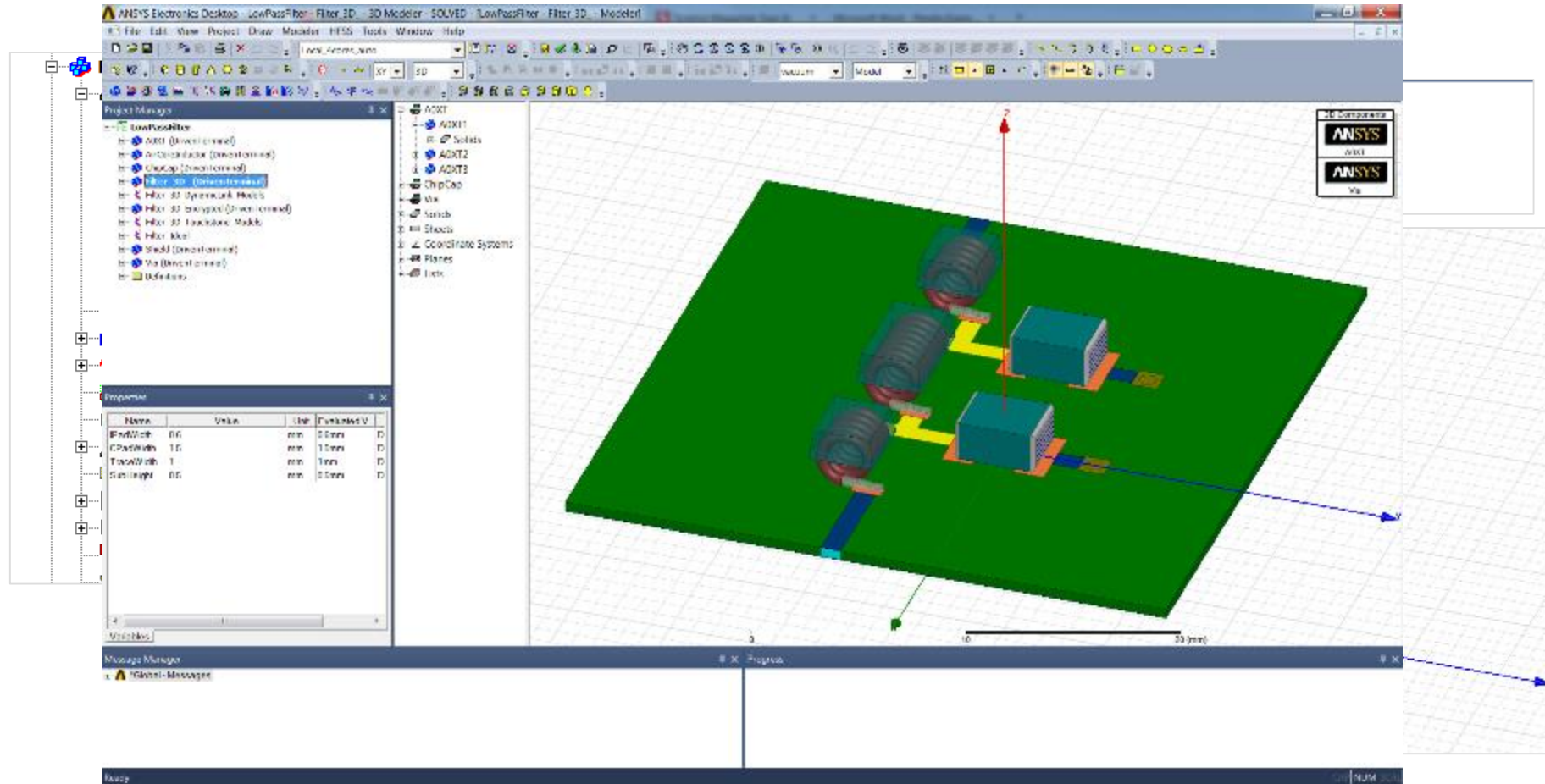

ANSYS HFSS 3D Components

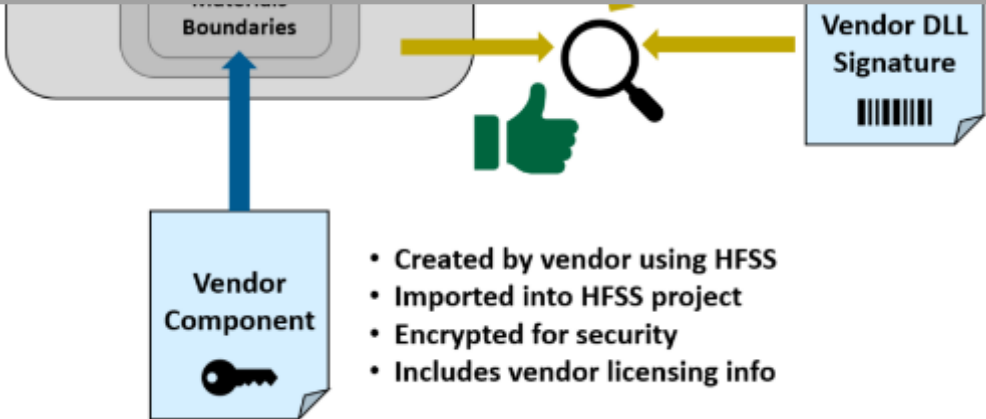
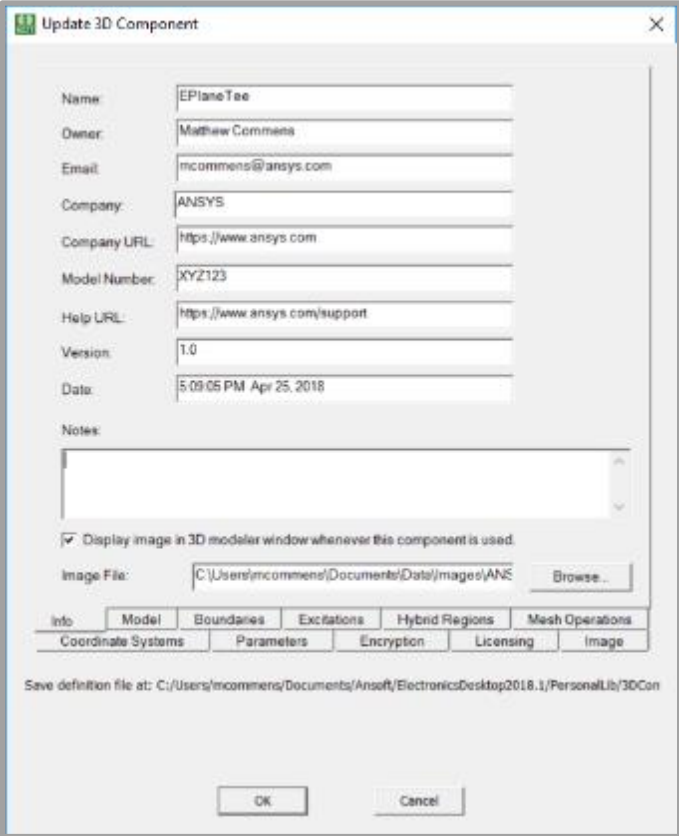
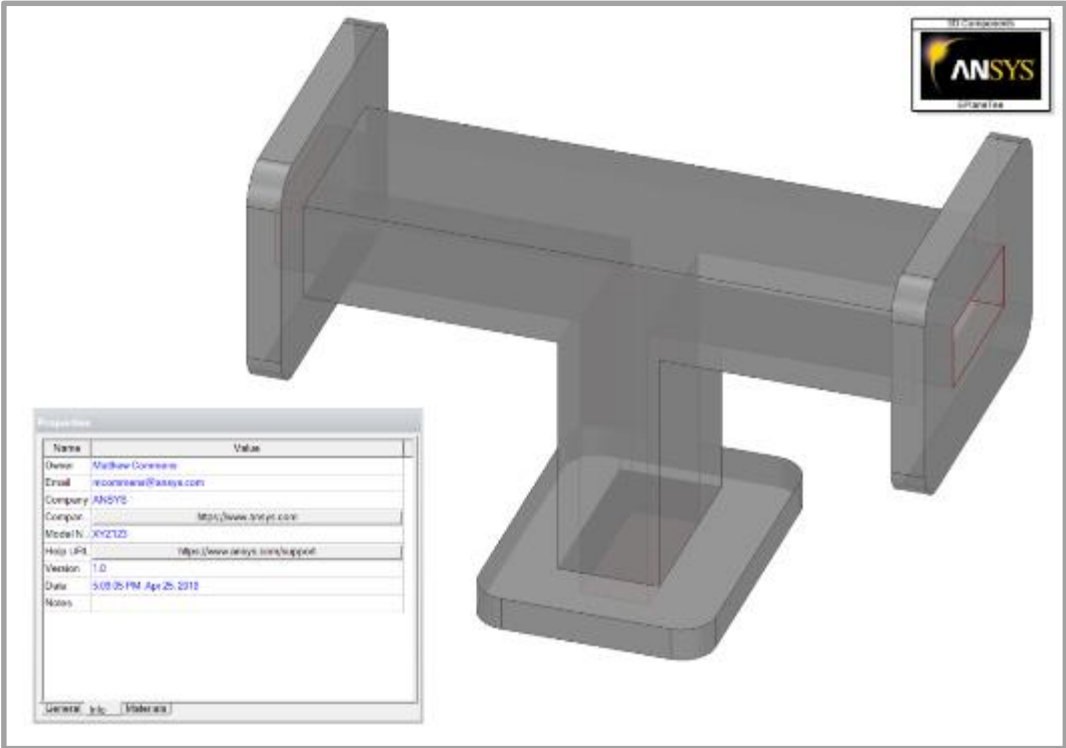

- Created by vendor using HFSS
- Imported into HFSS project
- Encrypted for security
- Includes vendor licensing info

Creating a 3D Component

- To create component select objects from modeler window and go to
 - “Create 3D Component...”
- Enter Design information
- Select parameters to include
 - Objects
 - Boundary conditions and excitations
 - Design parameters
- Review image
- Save to system, user or personal library folders
 - Update menu

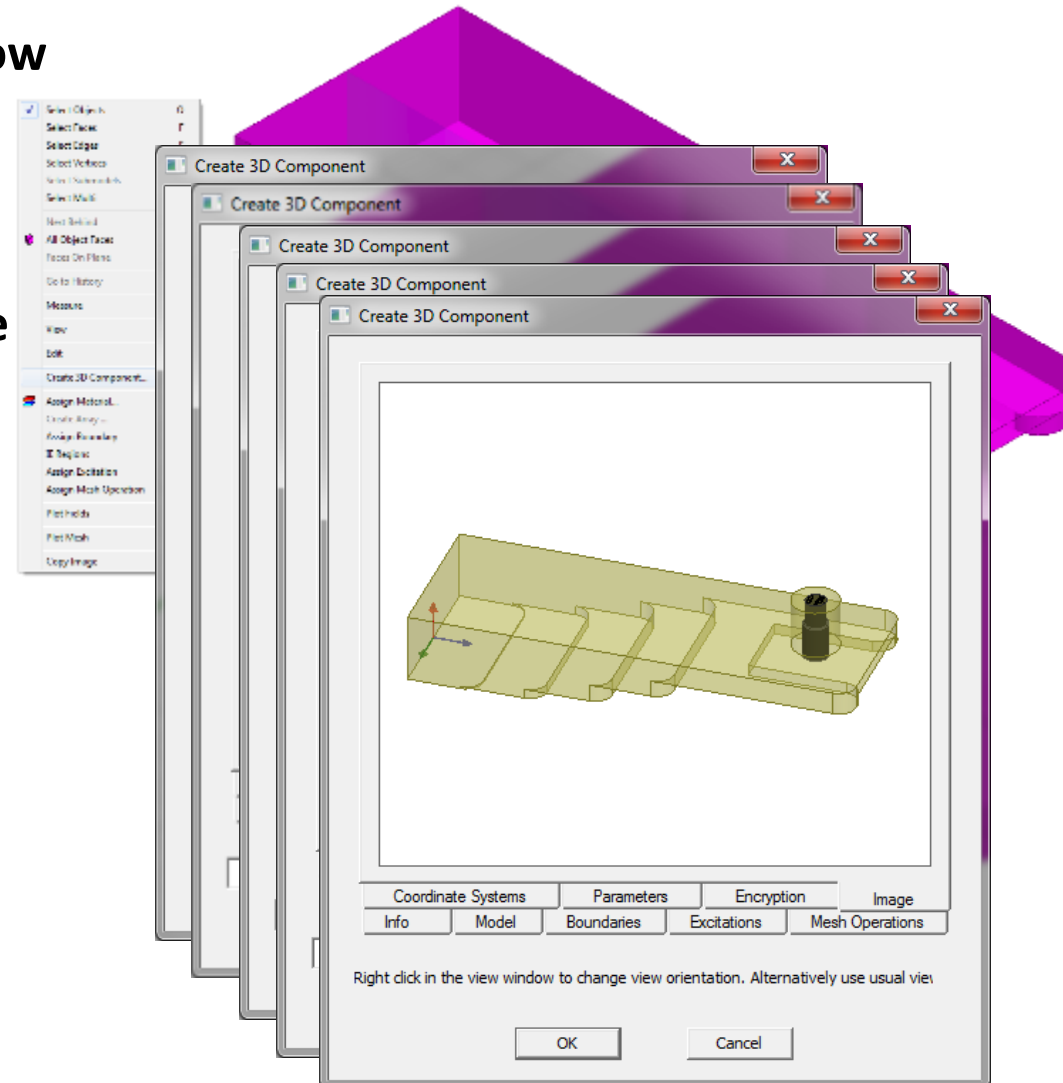

Inserting a component

- **Insert 3D Component**
 - Review Parameters
- **Component in model and project trees**
- **Component design data in project tree**
- **Component parameters in the property box**
- **Treat as custom defined 3D primitive**

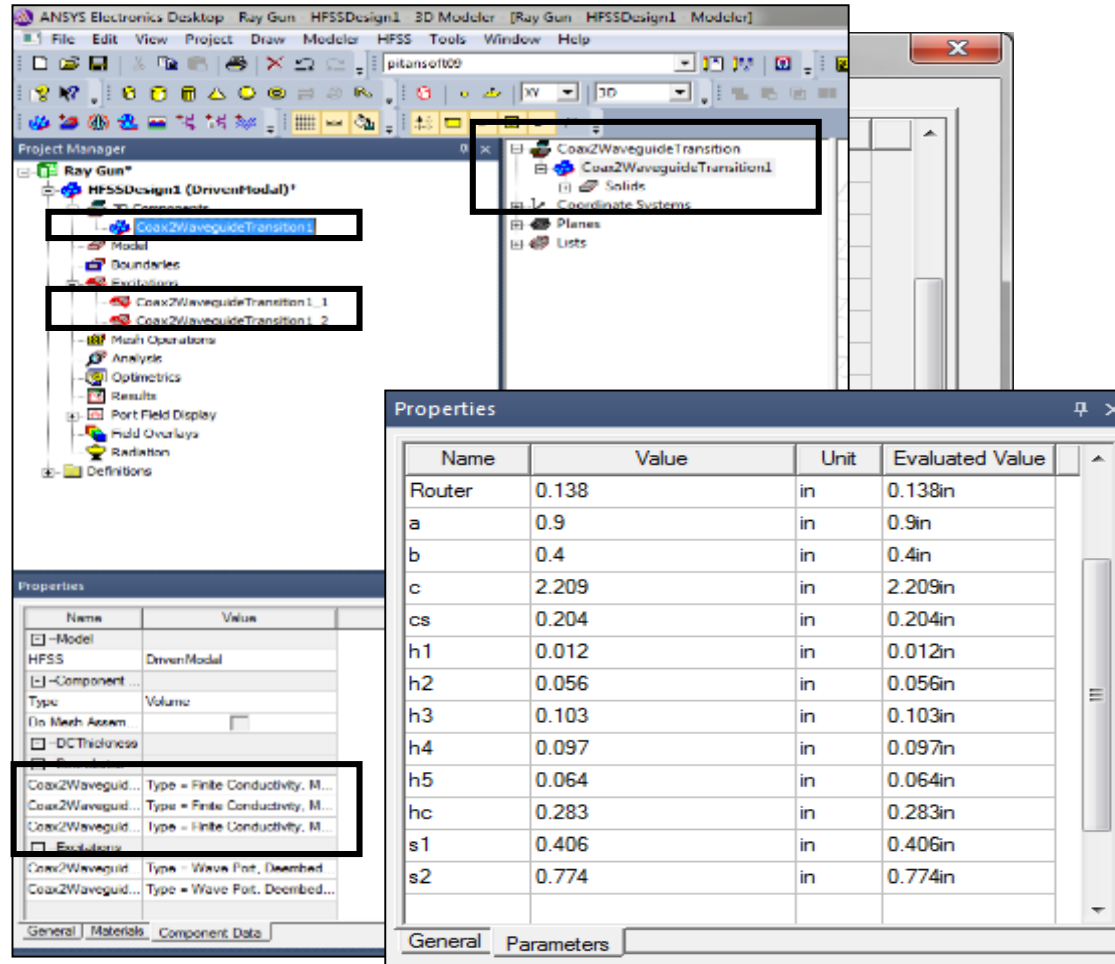

The screenshot shows the ANSYS Electronics Desktop interface. The Project Manager tree on the left shows the component 'Coax2WaveguideTransition' added to the model. The Properties dialog box is open, displaying a table of parameters for the component.

Name	Value	Unit	Evaluated Value
Router	0.138	in	0.138in
a	0.9	in	0.9in
b	0.4	in	0.4in
c	2.209	in	2.209in
cs	0.204	in	0.204in
h1	0.012	in	0.012in
h2	0.056	in	0.056in
h3	0.103	in	0.103in
h4	0.097	in	0.097in
h5	0.064	in	0.064in
hc	0.283	in	0.283in
s1	0.406	in	0.406in
s2	0.774	in	0.774in

3D Component Assembly Meshing

- Per-component model settings
- Per-component mesh
- Mesh in parallel
- ECAD+MCAD mesh assembly process
- Component based units
- Overcomes aspect ratio issues
- Multiple instances for same component
- Mesh re-use for parametric analysis

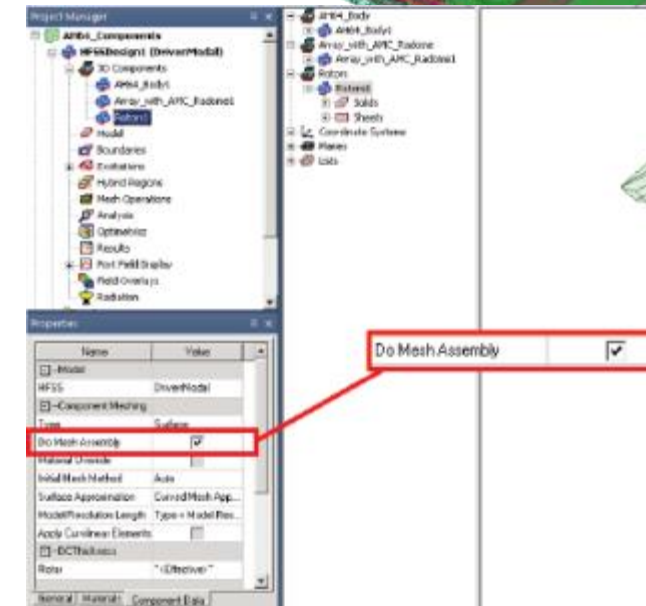
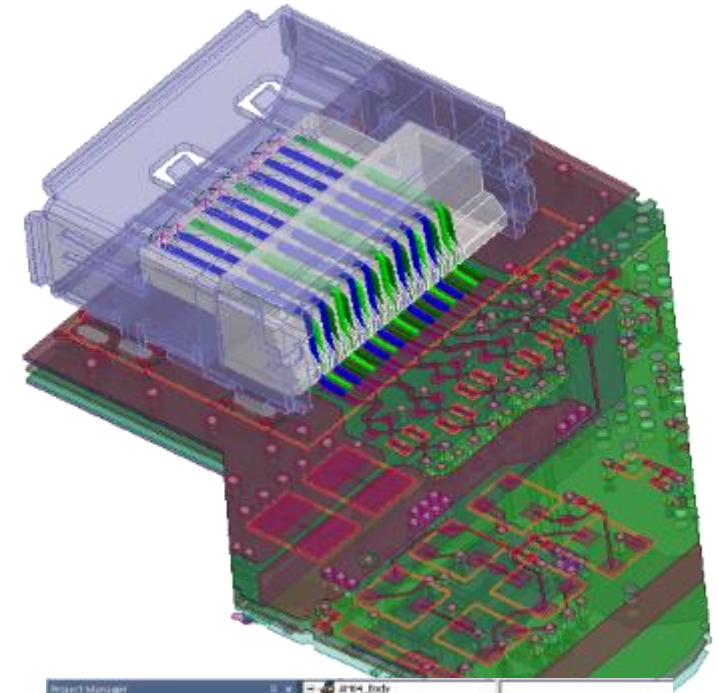



AEDT Thermal Analysis

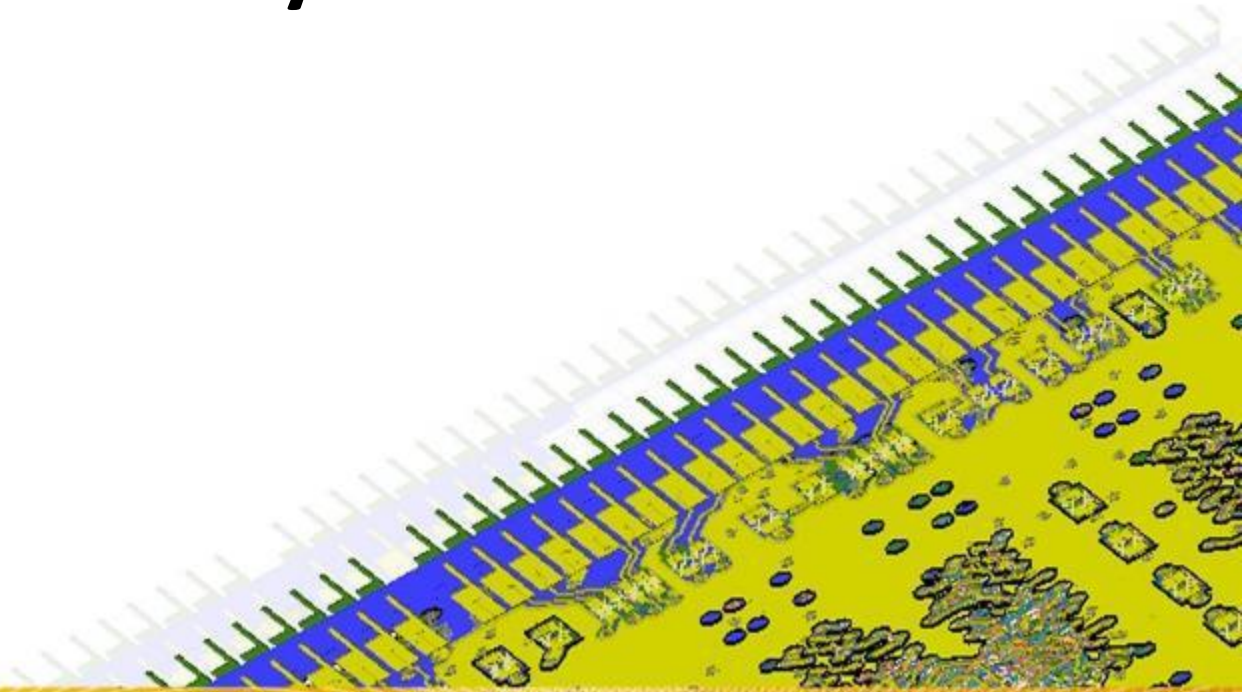

ANSYS Icepak – Computation Fluid Dynamics Solver

Icepak is an integrated “Electronics Cooling” solution for connectors, packages, printed circuit boards and electronic systems

- Fluid flow
- Conjugate heat transfer
- Steady-State Thermal
- Multi-physics coupling
- Single or multiple fluids
- Parametrics
- Optimization

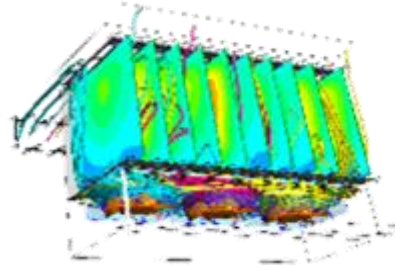

Velocity streamlines and temperature contours for a card array in a VME box cooled by three axial fans

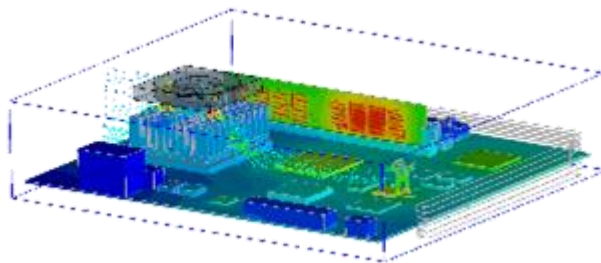

Temperature contours and fluid velocity vectors of a fan cooled rack mounted computer

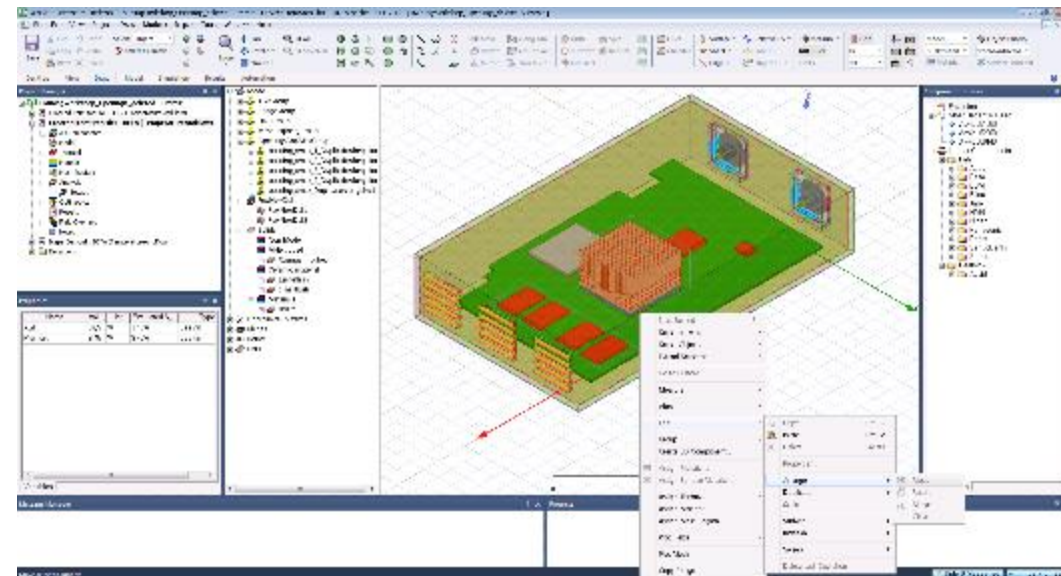

Icepak – ANSYS Electronics Desktop Integration

- Supported Workflows
 - MCAD Support
 - ECAD PCB workflow
 - EM loss coupling with HFSS, Maxwell and Q3D
 - Efficient Electronics Cooling CFD solution
 - Setup -> Meshing -> Solution (HPC)
 - Optimetrics and integrated post-processing
- Supported Thermal Physics
 - Steady-state flow and thermal
 - Conjugate heat transfer, including radiation
 - Laminar and turbulent flow modeling
- Modeling
 - Comprehensive thermal and flow boundary conditions
 - Native 3D Components : Fans (2D & 3D), Heatsinks, PCBs
- Libraries
 - Complete solid, fluid and surface materials library
 - Vendor component libraries: Fans, Heatsinks, BGA Components

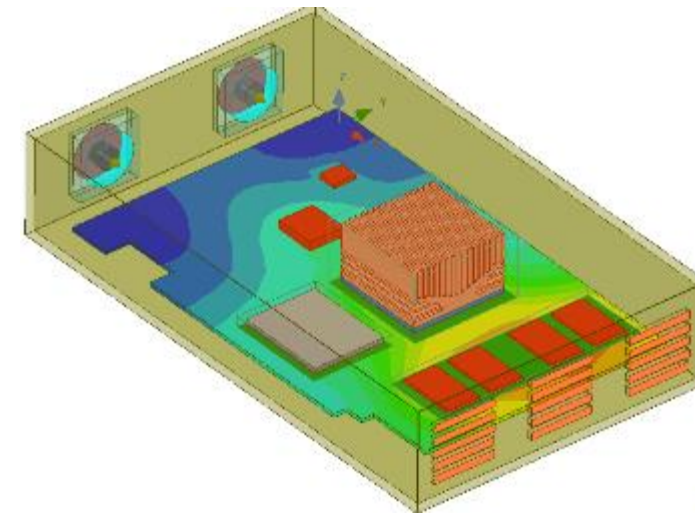
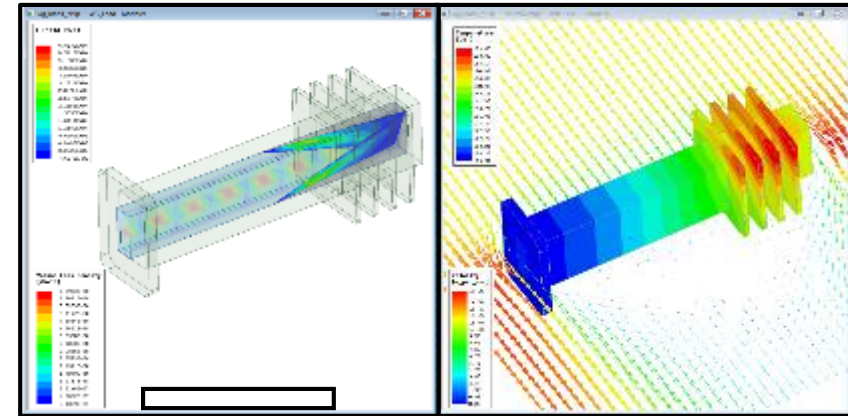

Material Library for Electrical, Thermal, & Mechanical

The image displays two windows from the ANSYS software interface. The left window is the 'Select Definition' dialog, showing a table of materials with columns for Name, Location, Origin, Thermal Conductivity, Mass Density, Specific Heat, Thermal Expansivity Coefficient, and Thermal Material Type. The right window is the 'View / Edit Material' dialog, showing the material name 'Carbon Dioxide(@300K)' and a table of its properties.

Select Definition Dialog:

Name	Location	Origin	Thermal Conductivity	Mass Density	Specific Heat	Thermal Expansivity Coefficient	Thermal Material Type
SmCo28	SysLibrary	Materials	10	8300	350	(8e-006, 1, 1e-00,...	Solid
SmCo24	SysLibrary	Materials	10	8300	350	(9e-006, 1, 1e-00,...	Solid
Ceramic8D	SysLibrary	Materials	4.5	4900	800	(1, 4e-005, 1e-00,...	Solid
Ceramic5	SysLibrary	Materials	4.5	4900	800	(1, 4e-005, 1e-00,...	Solid
Oxygen(@3...	SysLibrary	Materials	0.0323	1.3	920	0.486	Fluid
Oxygen	SysLibrary	Materials	0.0323	1.4	920	0.486	Fluid
Carbon Diox...	SysLibrary	Materials	0.0223	1.79	871	0.371	Fluid
Nitrogen(@3...	SysLibrary	Materials	0.0309	1.123	1041	0.003674	Fluid
Nitrogen	SysLibrary	Materials	0.0309	1.25	1040.67	0.003674	Fluid
Helium(@36...	SysLibrary	Materials	0.1777	0.133	5200	0.003658	Fluid
Helium	SysLibrary	Materials	0.1777	0.14	5200	0.003658	Fluid

View / Edit Material Dialog:

Material Name: Carbon Dioxide(@300K) | Material Coordinate System Type: Cartesian

Name	Type	Value	Units
Thermal Conductivity	Simple	0.0223	W/m-C
Mass Density	Simple	1.79	kg/m^3
Specific Heat	Simple	871	J/kg-C
Thermal Expansion Coefficient	Simple	0.371	1/C
Thermal Material Type		Fluid	
Thermal Diffusivity	Simple	1.059e-005	m^2/s
Molecular Mass	Simple	0.04401	kg/kmol
Dynamic Viscosity	Simple	1.495e-005	kg/m-s

View/Edit Material for: Active Design, Active Project, All Properties

Physics: Electromagnetic, Thermal, Structural

View/Edit Modifier for: Thermal Modifier

Material Appearance: Use Material Appearance, Color: [Color Picker], Transparency: 0.95

Buttons: Reset, OK, Cancel, Validate Material

Materials for Thermal Physics

- **Surface materials** : Paint, metals, plastics etc.
- **Solid materials** : Insulations, epoxy, metals, Heat-spreaders, package materials, etc.
- **Fluid materials** : Liquid, gaseous materials relevant to electronics cooling applications

Integrated with ANSYS Electronics Desktop

- **Leverage Electronics Desktop HPC Platform**
 - Easy to use
 - Includes Linux scheduler integration
- **Progress and Profile Reporting**
 - Meshing and solution process
 - Enhanced profile reporting
 - EM loss assignment

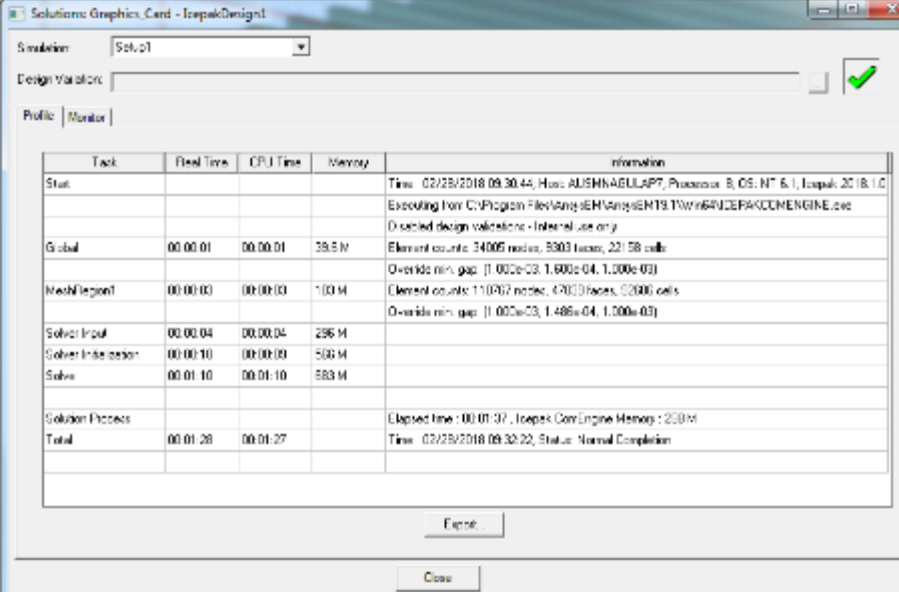

Screenshot of ANSYS Electronics Desktop showing a simulation profile report for 'Solu1'. The report includes a table with columns for Task, Real Time, CPU Time, Memory, and Information.

Task	Real Time	CPU Time	Memory	Information
Start				Time: 02/25/2018 09:30:44; Host: AJISHNAGULAP7; Processor: 8; OS: NT 6.1; Icepak: 2018.1.0
Global	00:00:01	00:00:01	39.5 M	Executing from C:\Program Files\ANSYS\EM\Icepak\EM19.1\Win64\ICEPAKCOMENGINE.exe Disabled design validations - Internal use only Element counts: 34005 nodes, 5903 faces, 22158 cells O-voids min-gap: [1.002e-03, 1.600e-04, 1.000e-03]
MeshRegion1	00:00:00	00:00:00	100 M	Element counts: 110767 nodes, 47033 faces, 62000 cells O-voids min-gap: [1.002e-03, 1.486e-04, 1.000e-03]
Solver Input	00:00:04	00:00:04	295 M	
Solver Initialization	00:00:10	00:00:09	500 M	
Solve	00:01:10	00:01:10	583 M	
Solution Process				Elapsed time: 00:01:37; Icepak Com Engine Memory: 230 M
Total	00:01:26	00:01:27		Time: 02/25/2018 09:32:22; Status: Normal Completion

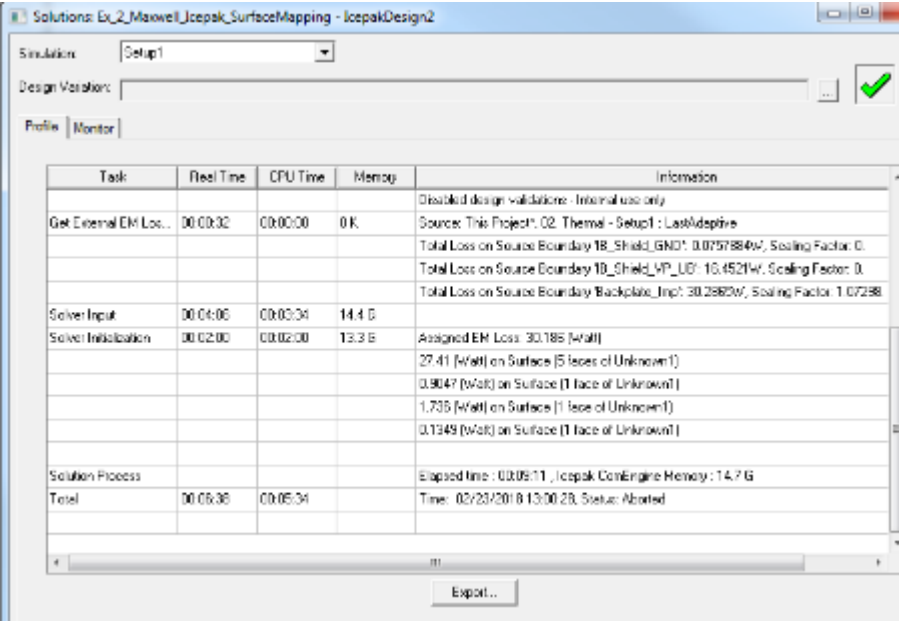

Screenshot of ANSYS Electronics Desktop showing a simulation profile report for 'Setup1'. The report includes a table with columns for Task, Real Time, CPU Time, Memory, and Information.

Task	Real Time	CPU Time	Memory	Information
Get External EM Loss	00:00:32	00:00:00	0 K	Disabled design validations - Internal use only Source: This Project: 02_Thermal - Setup1: LastAdaptive Total Loss on Source Boundary 18_Shield_GND1: 0.0757884W, Scaling Factor: 0 Total Loss on Source Boundary 10_Shield_VP_UD1: 10.4521W, Scaling Factor: 0 Total Loss on Source Boundary Backplate_Inf1: 30.2882W, Scaling Factor: 1.07288
Solver Input	00:04:06	00:03:34	14.4 G	
Solver Initialization	00:02:00	00:02:00	13.3 G	Assigned EM Loss: 30.185 [Watt] 27.41 [Watt] on Surface (5 faces of Unknown1) 0.9047 [Watt] on Surface (1 face of Unknown1) 1.735 [Watt] on Surface (1 face of Unknown1) 0.1349 [Watt] on Surface (1 face of Unknown1)
Solution Process				Elapsed time: 00:05:11; Icepak Com Engine Memory: 14.7 G
Total	00:06:38	00:05:34		Time: 02/23/2018 13:00:28; Status: Aborted

Icepak: Two-Way Coupling with HFSS, Maxwell, Q3D

- New Coupled Simulation Controller in Icepak Design
 - User specified “Number of Coupling Iterations”
 - Options to “continue” Icepak iterations during coupling
 - Single controller per design
- Updates to EM losses in each coupling iteration
- Multiple EM Losses supported
- Icepak-Optimetrics Integration

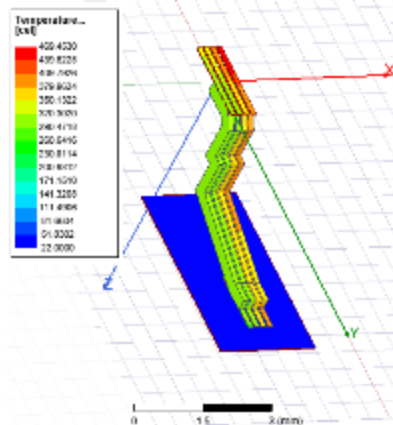
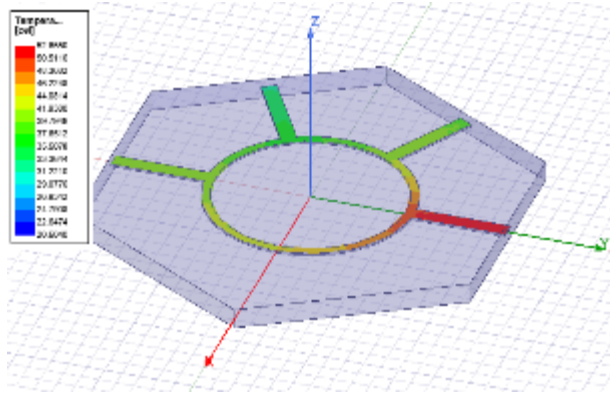
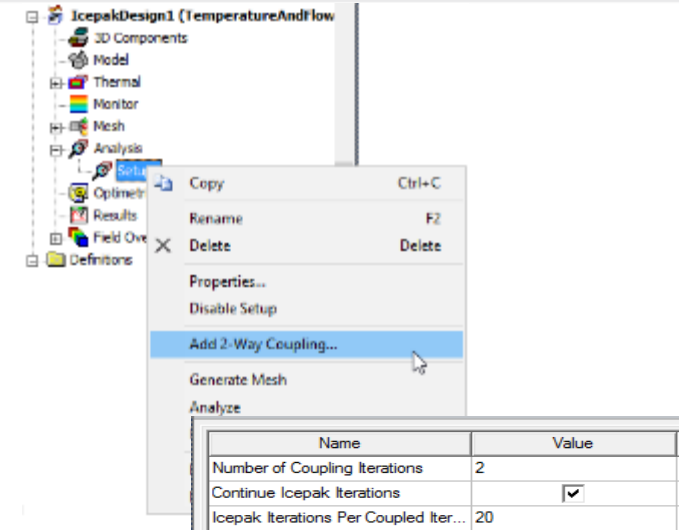

Solution DS 3: HFSS (R18.2) - IcepakDesign1

Simulator: F4x1

Design Monitor:

Item	Real Time	CPU Time	Memory	Information
Cost				Time: 10/12/2019 12:02:28; Job: Icepak Design1; Process: 2019-10-12; User: 2019-10-12
Global	00:00:04	00:00:04	111 M	Flowing from 'Project File' to 'Analysis' (2019-10-12 12:02:28) - HFSS (R18.2)
Prepare Solution	00:00:02	00:00:06	211 M	Case # source: 11085; nodes: 2002; faces: 13200; cells:
Coupling Iteration 1				
For Values of EM Loss Data	00:00:05	00:00:00	0 K	Value: 101.1; Project: HFSS (R18.2); Solution: Local Solution
EM Loss Data	00:00:04	00:00:08	402 M	EM Loss on Source boundary: 'Main' (1.02884); Scaling Factor: 1.4204
EM Loss Data	00:00:04	00:00:08	402 M	EM Loss on Source Object: 'Subcase' (0.042854); Scaling Factor: 1.4167
EM Loss Data	00:00:04	00:00:08	402 M	EM Loss on Surface (1 face of 2 cells)
EM Loss Data	00:00:04	00:00:08	402 M	EM Loss on Surface (3 faces of 2 cells)
EM Loss Data	00:00:04	00:00:08	402 M	EM Loss on Surface (1 face of 2 cells)
Coupling Iteration 2				
For Values of EM Loss Data	00:00:03	00:00:00	0 K	Value: 101.1; Project: HFSS (R18.2); Solution: Local Solution
EM Loss Data	00:00:03	00:00:08	402 M	EM Loss on Source boundary: 'Main' (1.02884); Scaling Factor: 1.4204
EM Loss Data	00:00:03	00:00:08	402 M	EM Loss on Source Object: 'Subcase' (0.042854); Scaling Factor: 1.4167
EM Loss Data	00:00:03	00:00:08	402 M	EM Loss on Surface (1 face of 2 cells)
EM Loss Data	00:00:03	00:00:08	402 M	EM Loss on Surface (3 faces of 2 cells)
EM Loss Data	00:00:03	00:00:08	402 M	EM Loss on Surface (1 face of 2 cells)
Solution Progress	00:00:04	00:00:07	200 M	Case: 2019-10-12; User: 2019-10-12
F4x1	00:00:04	00:00:08	200 M	Flowing from 'Project File' to 'Analysis' (2019-10-12 12:02:28) - HFSS (R18.2)

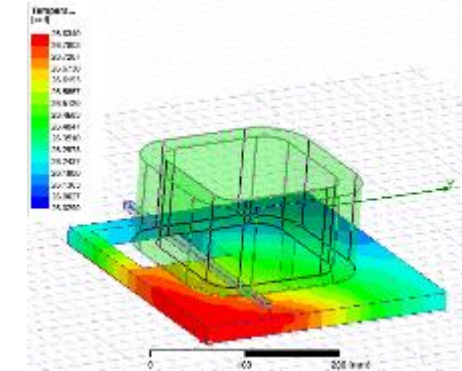

2-Way Electro-Thermal Coupling

- Valid for HFSS, Q3D, and Maxwell design types
- Utilizes thermal modifier for materials and temperature feedback in electromagnetic design
- New 2-way Coupling controller in Icepak design

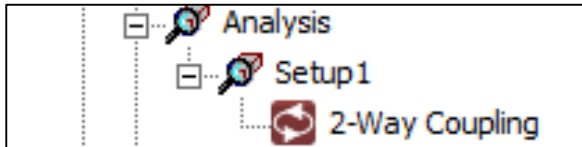
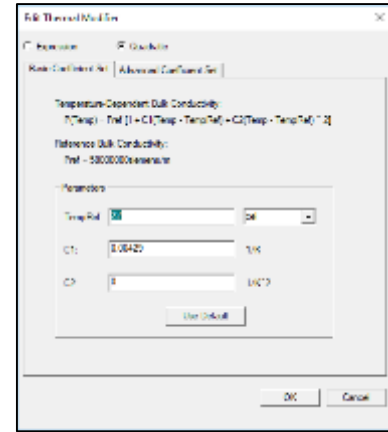

- Allows for additional Icepak iterations between material updates

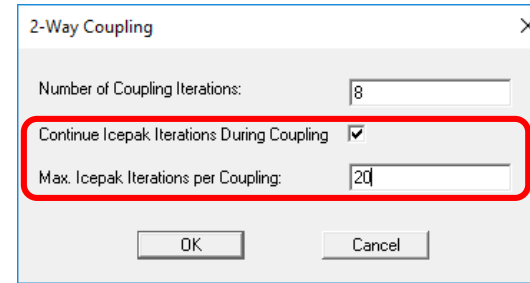

HFSS Design of a High Power Waveguide Load

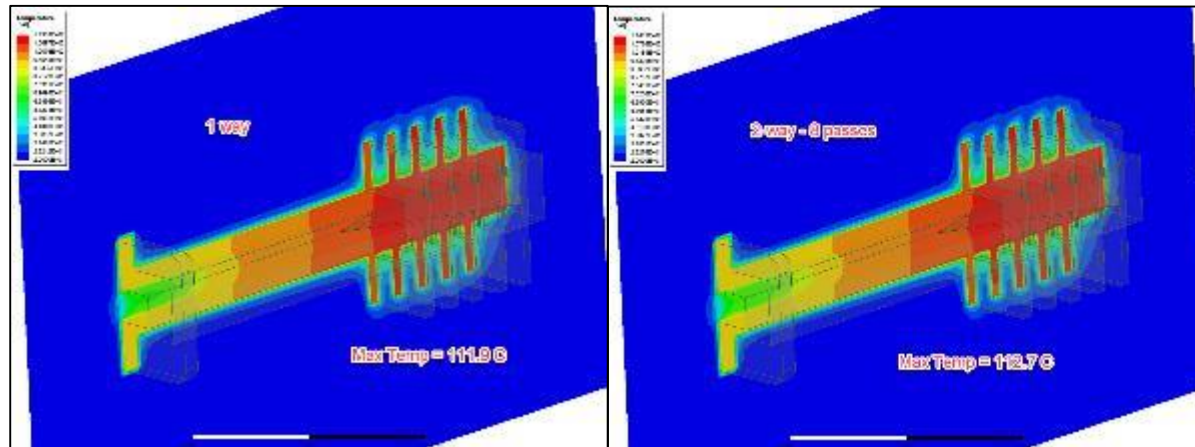

Maxwell Design of Planar Transformer

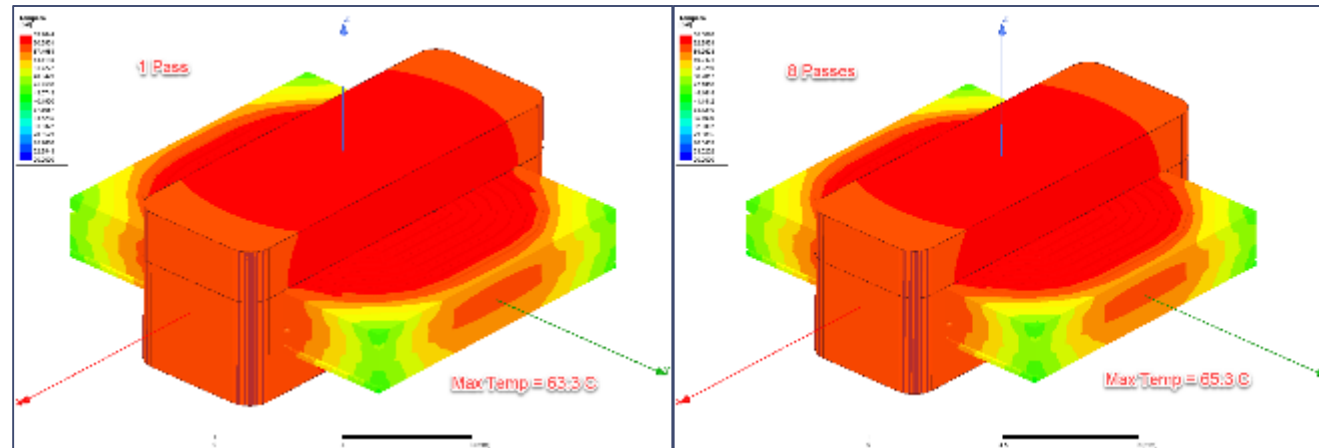

AEDT Icepak – Post-Processing

Thermal conductivity X

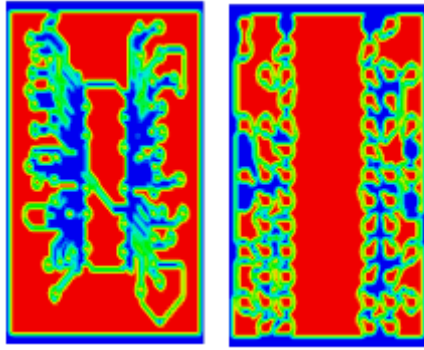

Top

Bottom

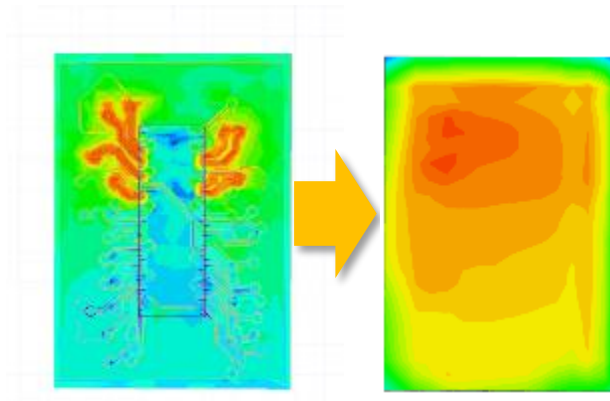

HFSS 3D layout Field

Temperature

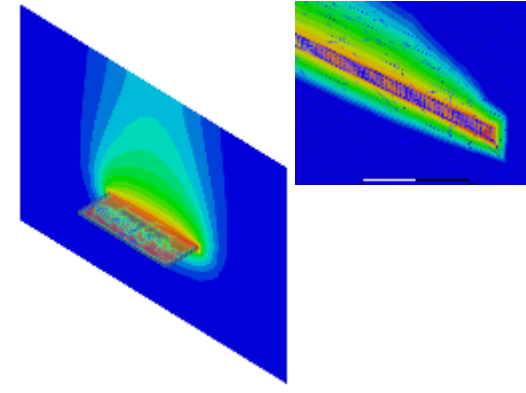

Thermal plot & PCB mesh

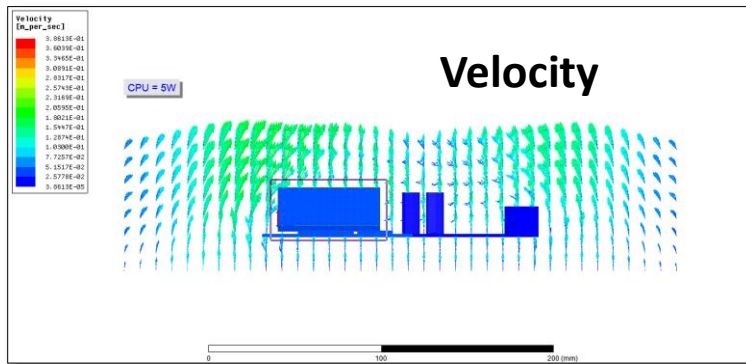

Velocity

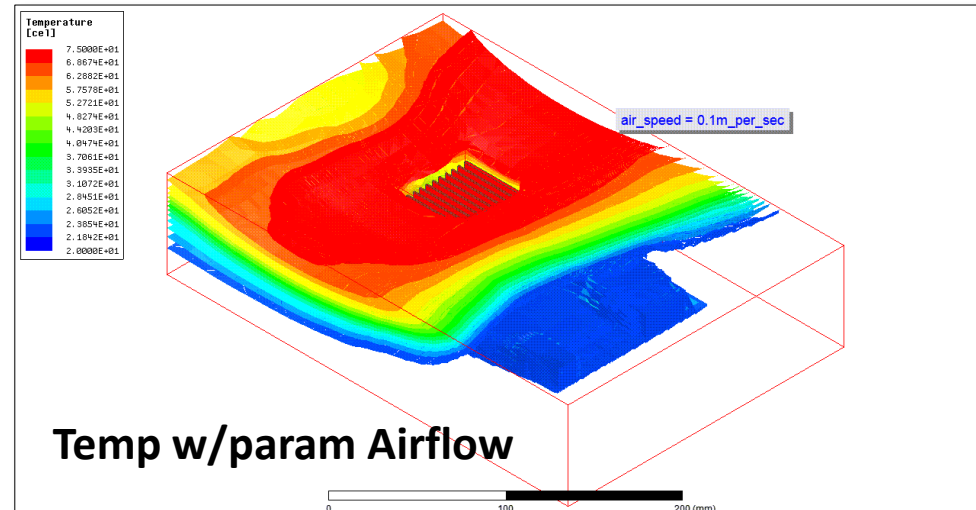

Temp w/param Airflow

Highlights

NEW

NEW

NEW

NEW

- 2-way thermal coupling to HFSS, Q3D, and Maxwell design types
- 1-way thermal coupling to Siwave DC IR solver in AEDT
- Import .t3r archive from Classic Icepak interface
- 2D & 3D profile boundary conditions using datasets
- Workflow Improvements
 - Solution setup streamlined
 - Rotated PCB components
 - MCAD fan objects can be simplified into Icepak primitives
- Mesher Improvements
 - General mesh speed and quality improvements
 - Allow for simplified stair-step meshing
 - Control over uniform mesh sizing
 - Added the capability to enforce 2D cut cell meshing in a specified coordinate direction
- Classic Icepak Enhancements
 - Job submission to supported schedulers – within and across Windows/Linux platforms
 - Ability to export unencrypted ECXML files
 - Monte Carlo radiation model added (BETA)

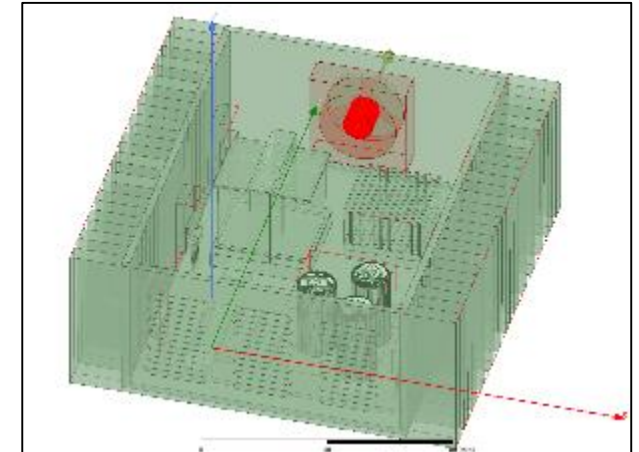
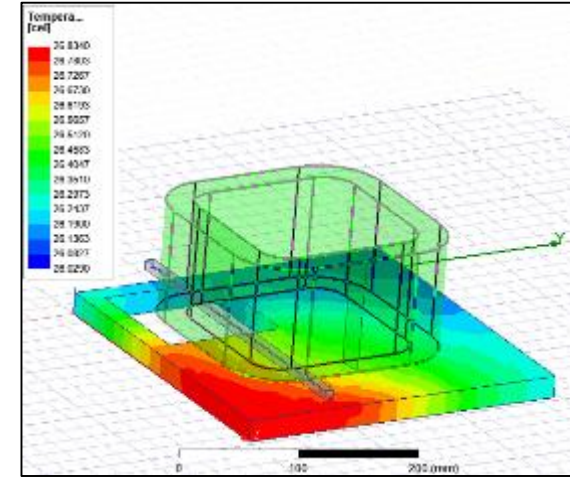

ANSYS[®]

EMI EMC

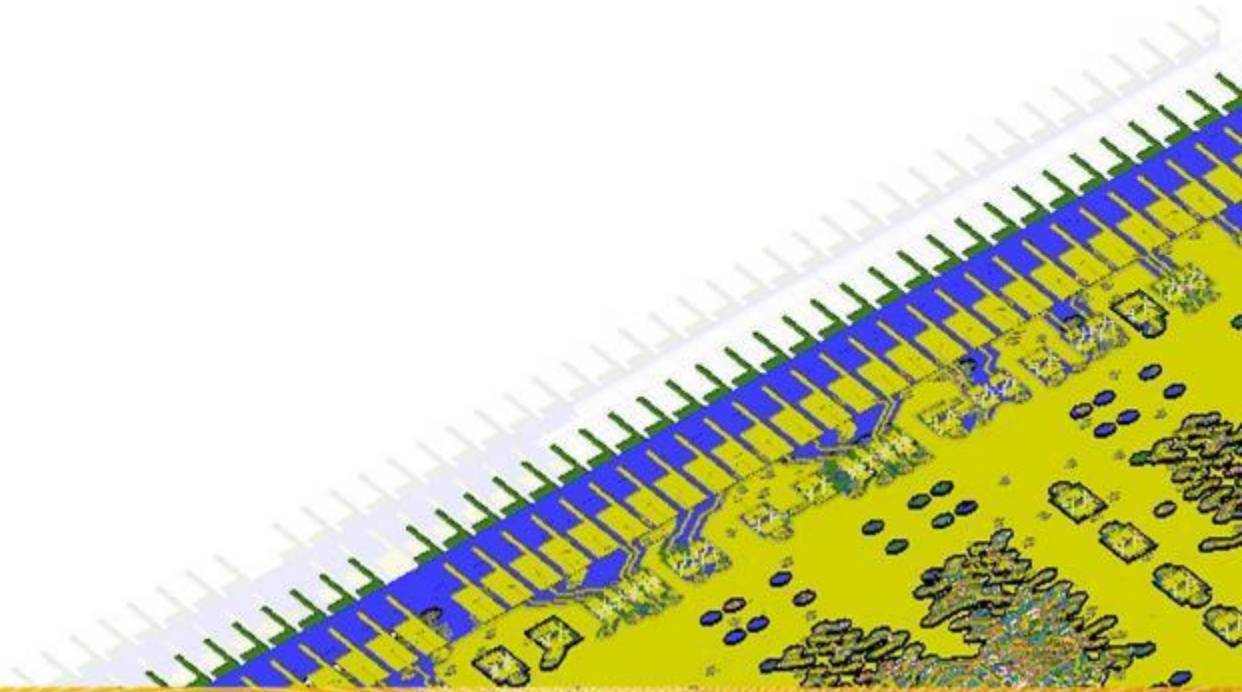

EMI Capabilities

- **Resonant Mode**
 - Power and ground plane resonant mode solver.
- **Induced Voltage (Susceptibility)**
 - Models a plane wave incident to the PCB. Monitors voltages induced at port locations.
- **Near-Field**
 - Computes the near-field E- and H- fields close to the board.
- **Far-Field**
 - Computes the far-field radiation.

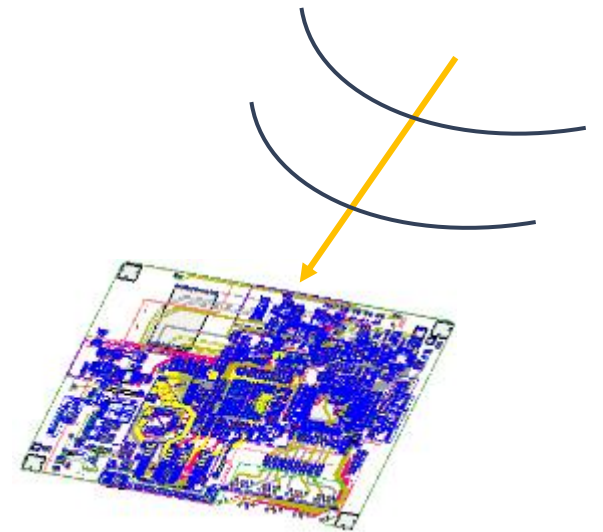
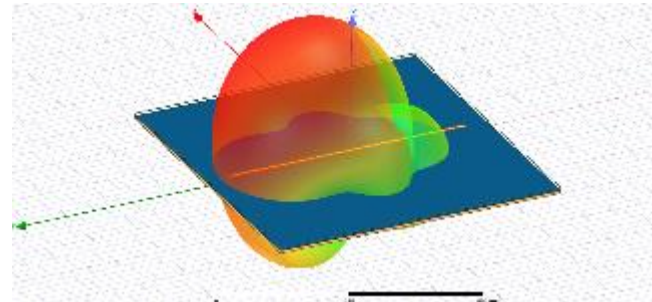
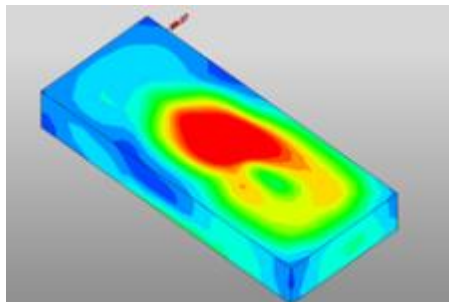
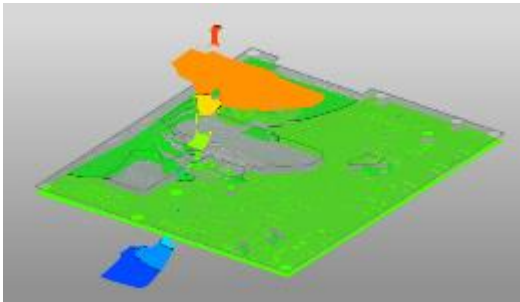

Induced Voltage (Susceptibility)

- Models a plane wave incident to the PCB
- Monitors traces and planes for excitation

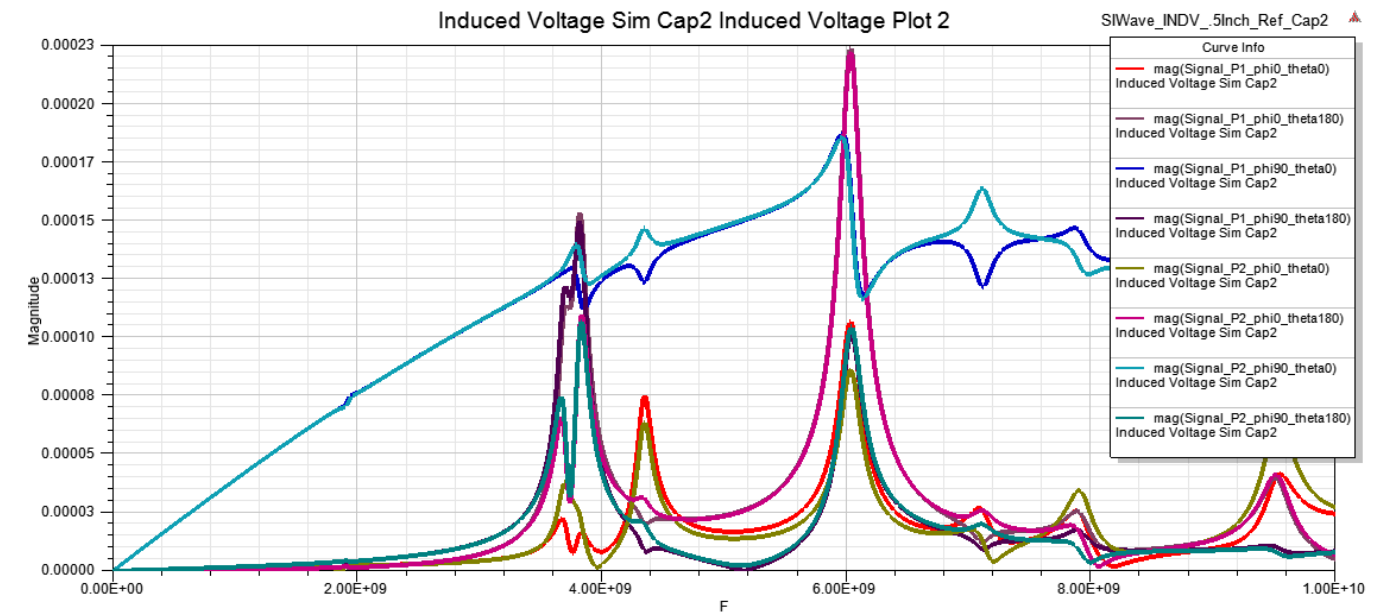
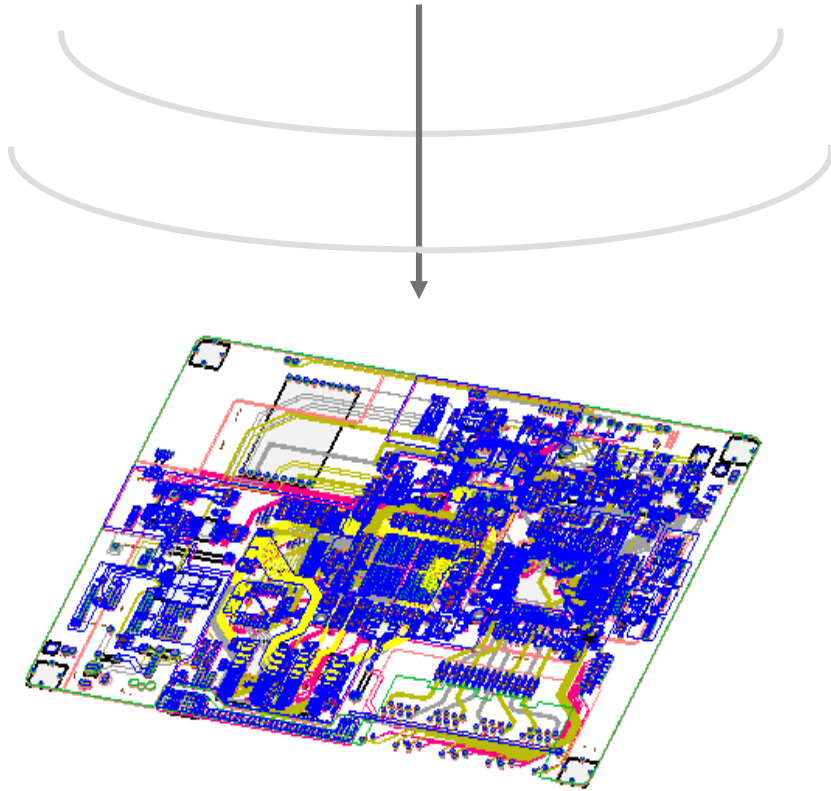

Induced Voltage – 10GHz Plane Wave Excitation

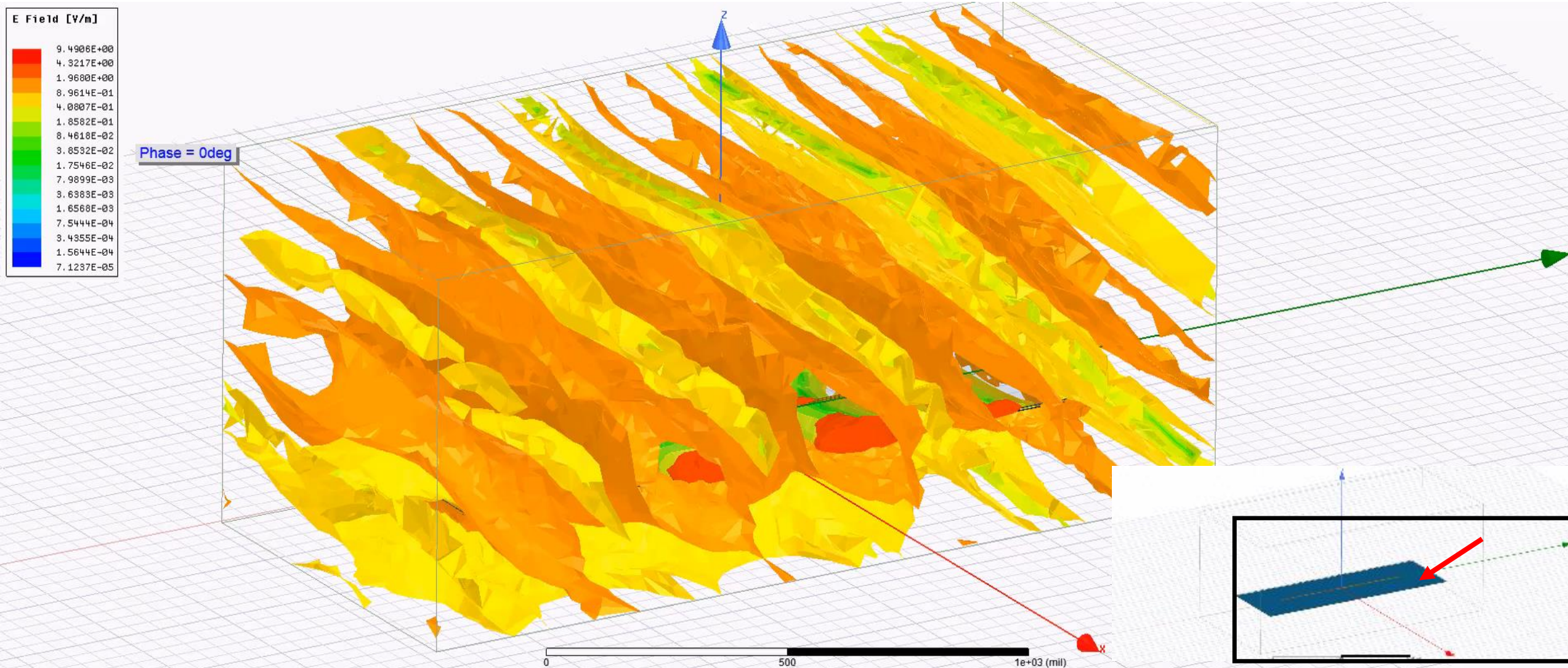

Animation

Near-Field

- Computes the near-field E- and H-field at a specified distance from the model
- Mimics near-field probing that is commonly done with a spectrum analyzer to pinpoint localized sources of EMI

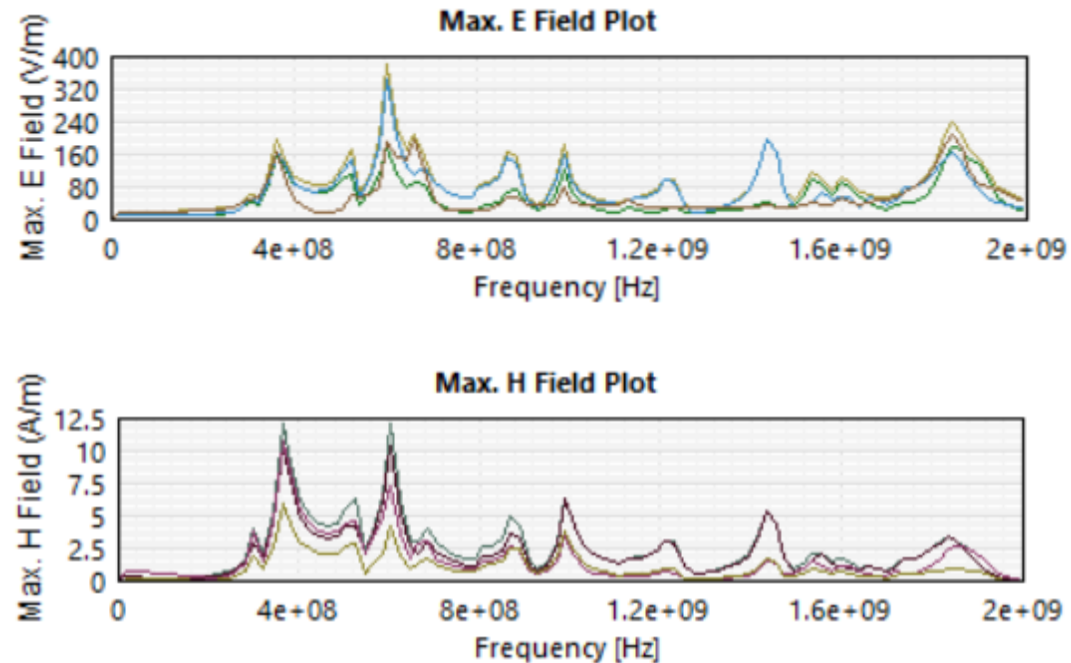

Near-Field E-Field Pattern

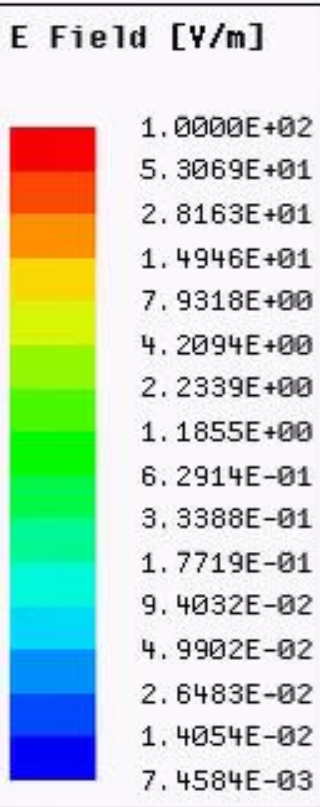

Phase = 0deg

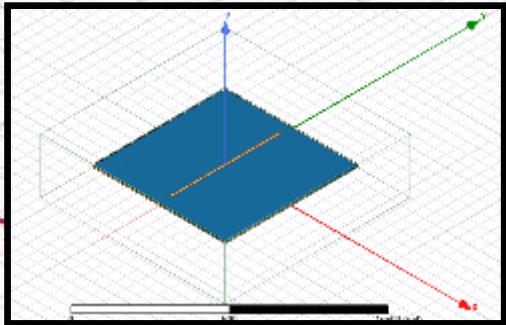

Far-Field

- Computes the radiation pattern and strength of the E-field in the far-field
- Mimics Radiated Emissions testing used for EMC Compliance
- Can be calculated for 3m, 5m, 10m testing

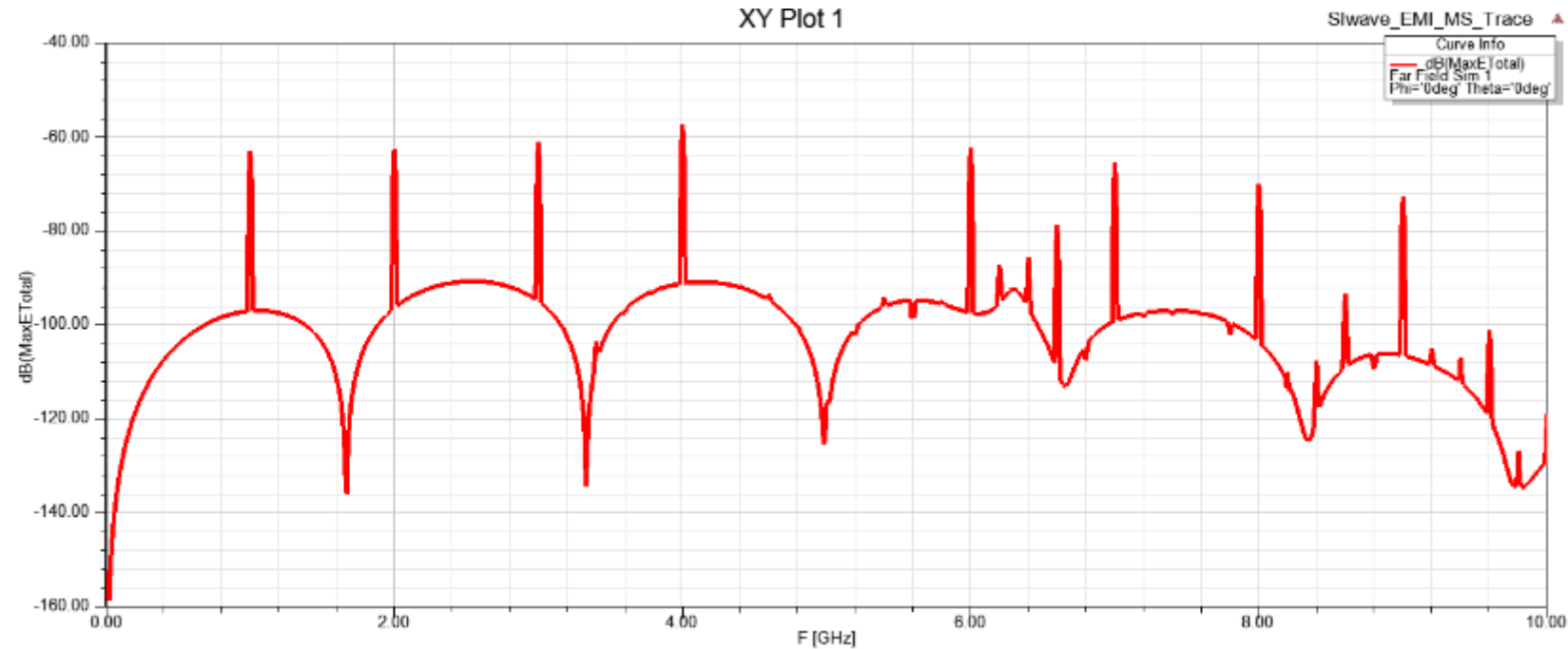

Far-Field Radiation Pattern

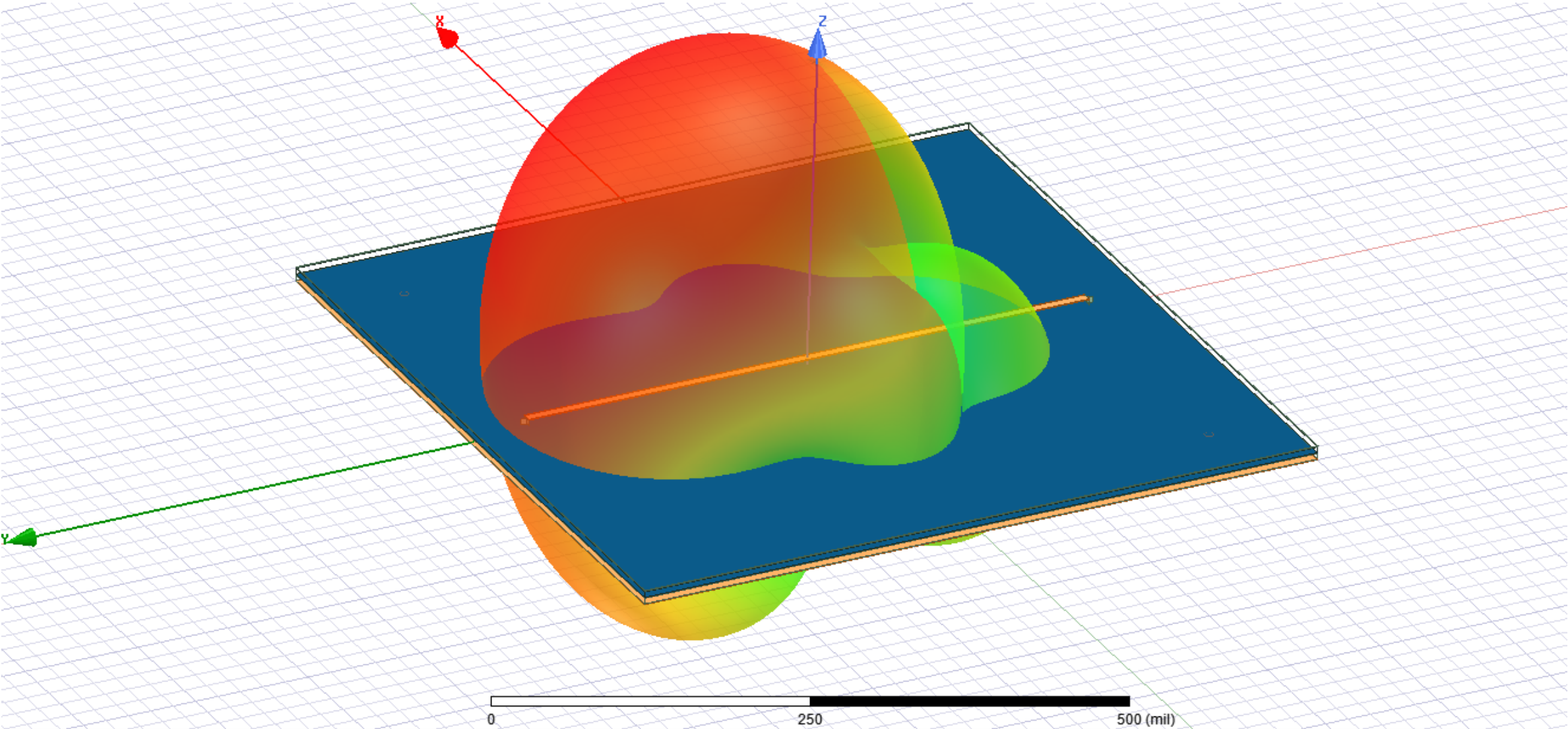

Microstrip w/ Slot – Varying Gap Width

Transmission Line models that assume perfect reference planes do not show the impact of non-ideal return paths. CM or DM radiation is proportional to the areas of the loops (s or h), which are set by the PCB/Connector technology and design strategies.

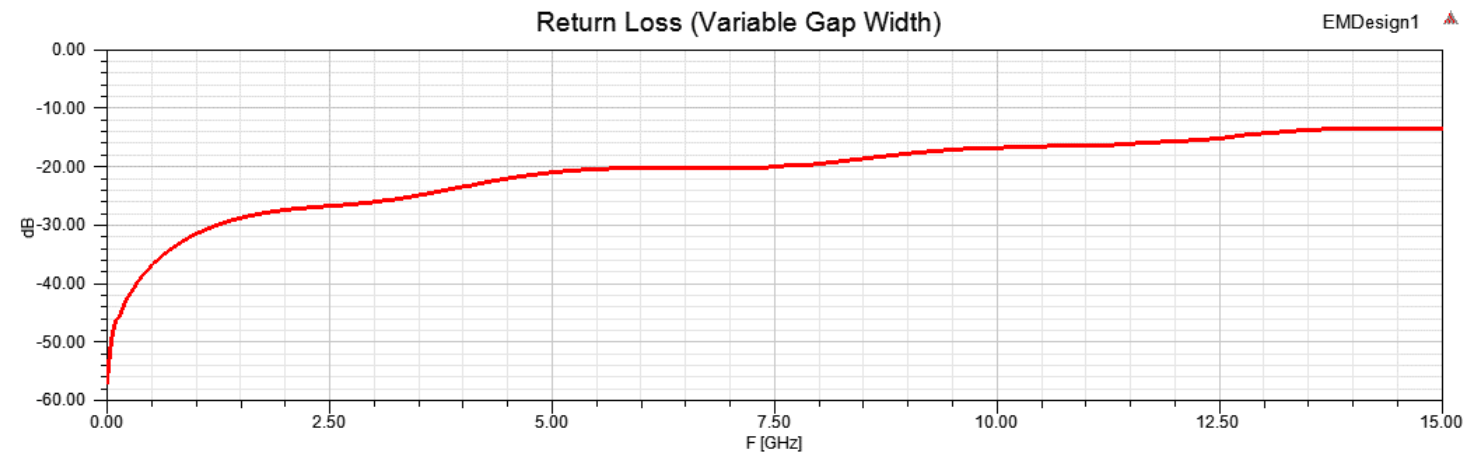
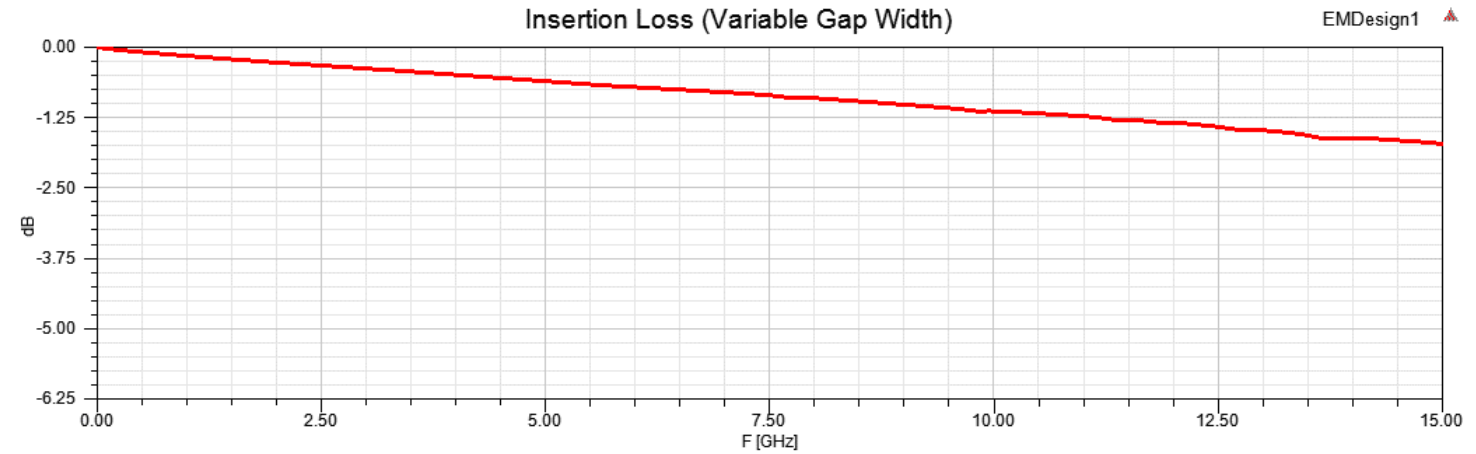
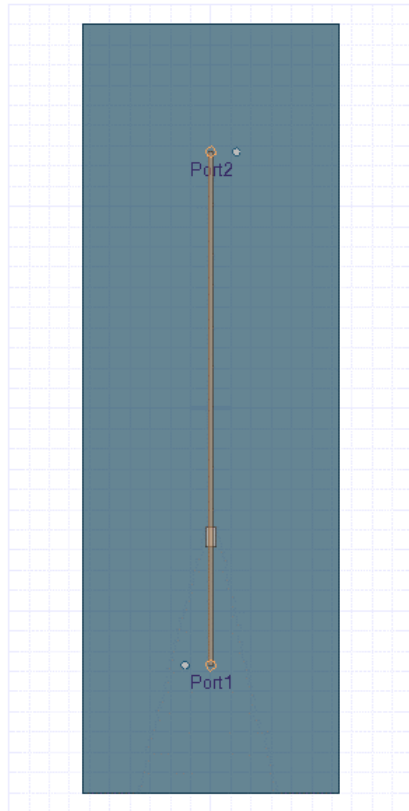

Animation

Near-Field E-Field – 2.1 GHz

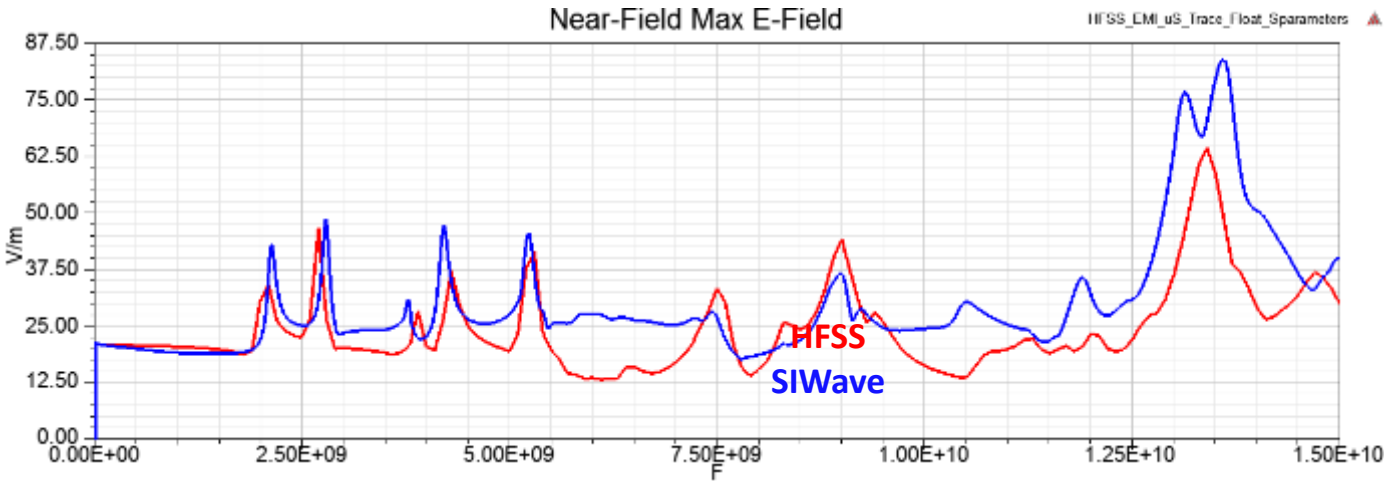
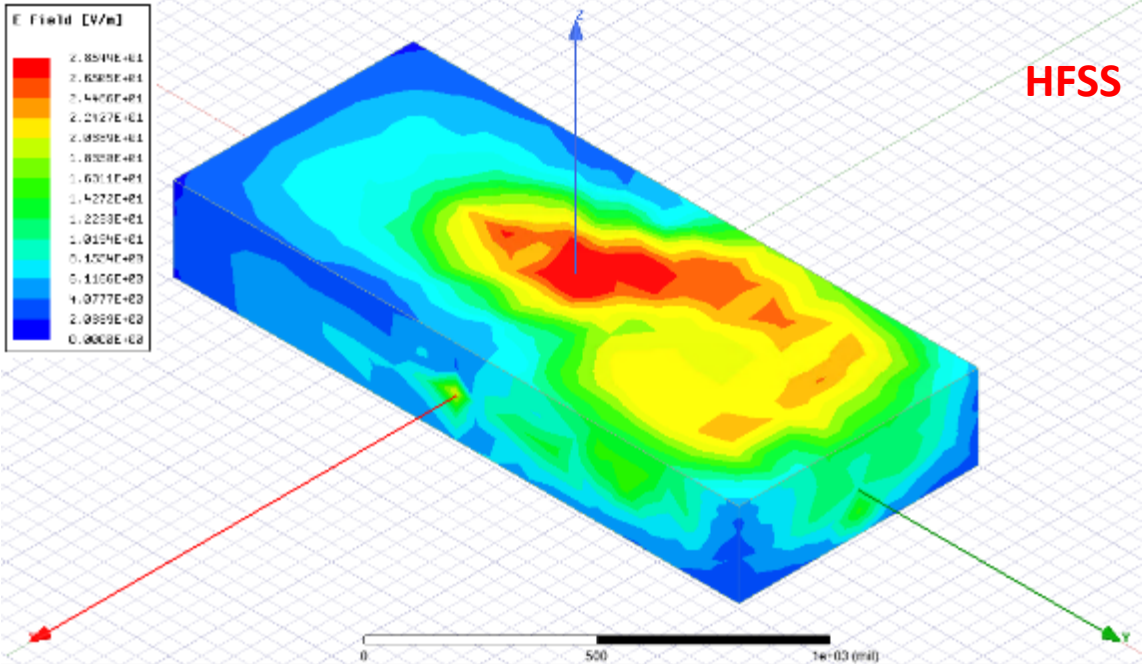
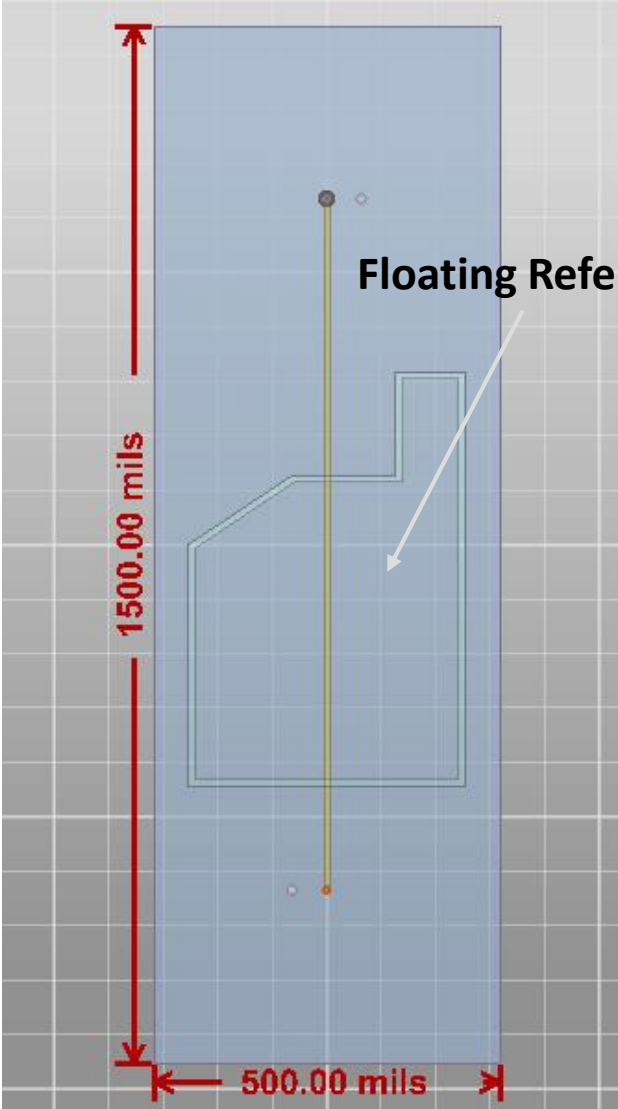

Microstrip w/ Slot - HFSS – Vector E-Field at 3mm above Slot

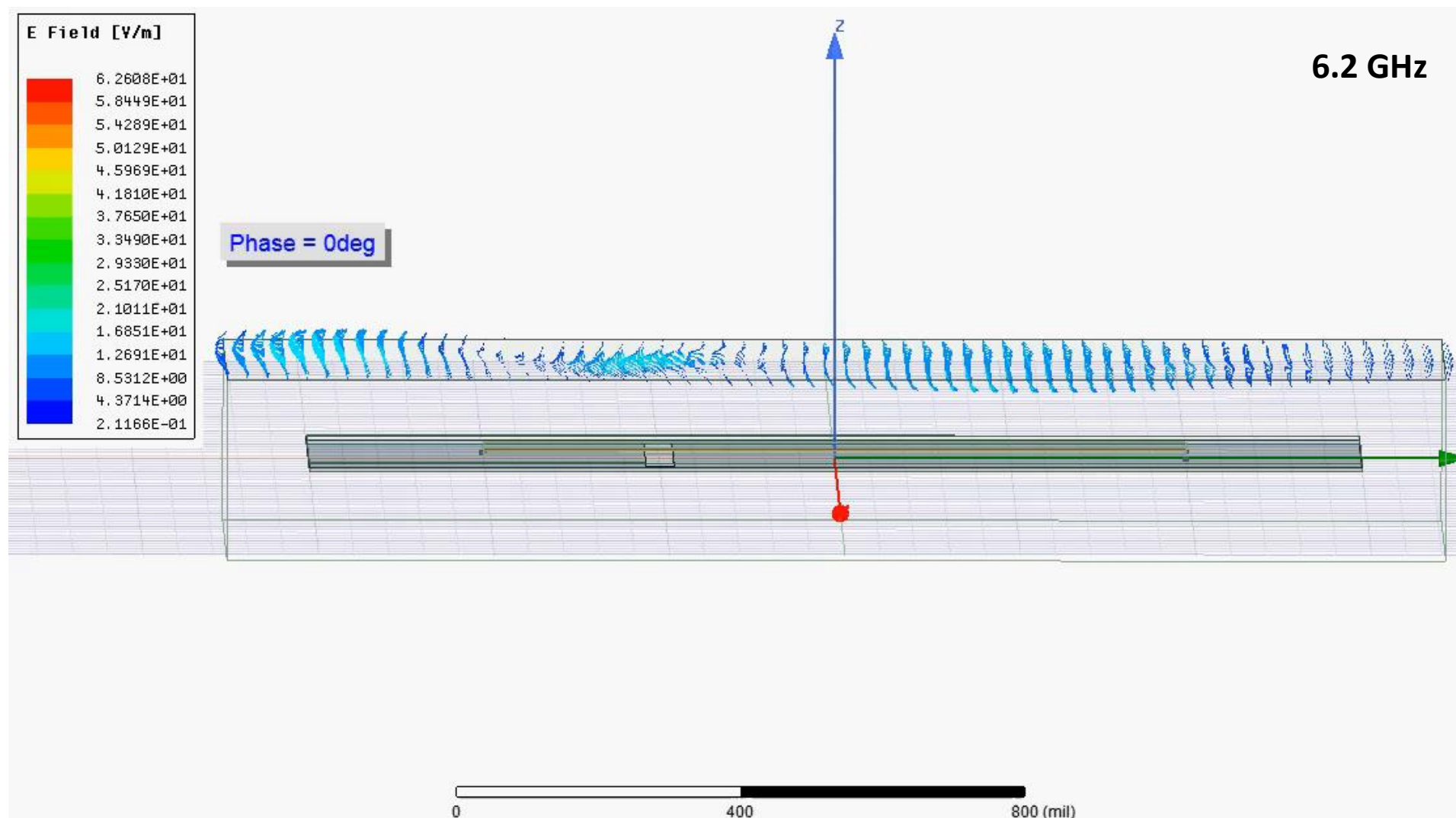

Animation

ANSYS EMI Scanner

- Either HFSS or Siwave can utilize the EMI Scanner
 - No additional license needed
 - EMI Scanner runs directly in either tool

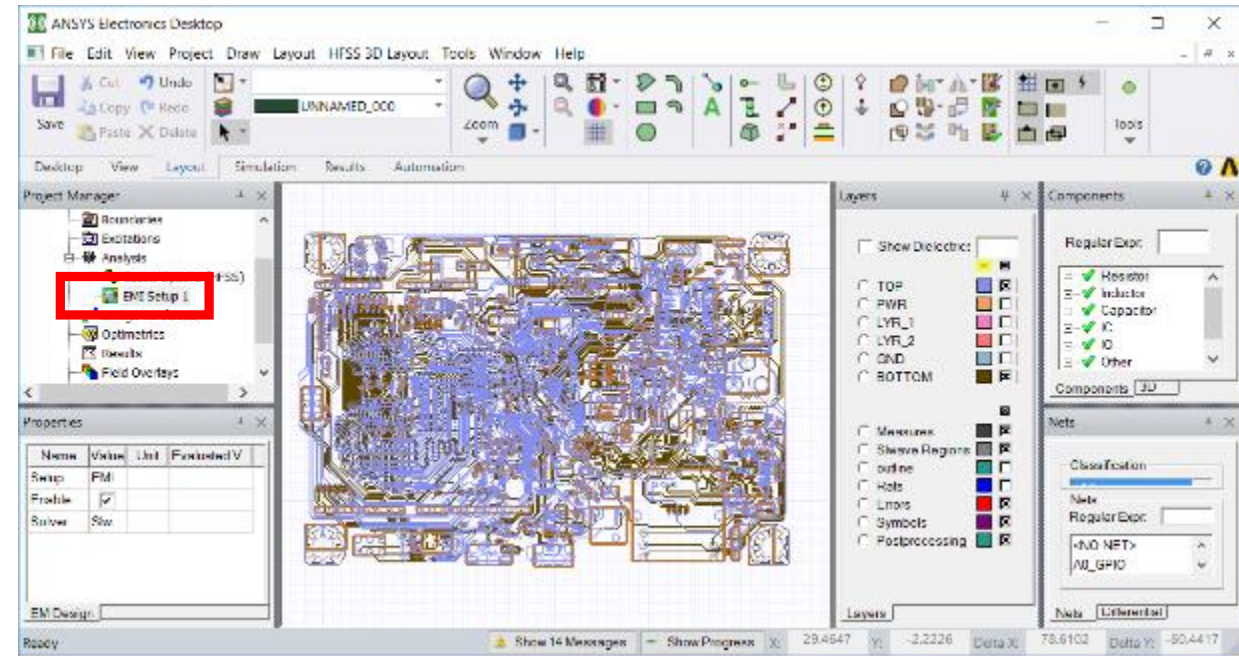
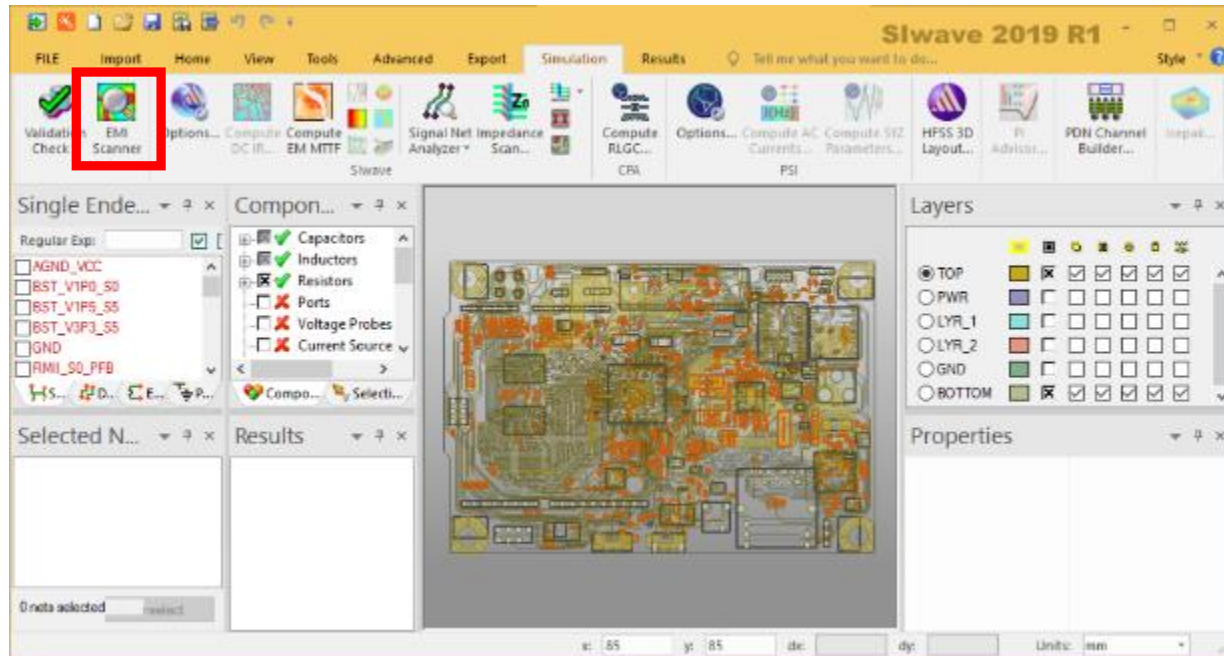

Electromagnetic Interference Rules

Signal Reference

- Net Crossing Split
- Net Changing Reference
- Net Near Edge of Reference

Example: Net Crossing Split

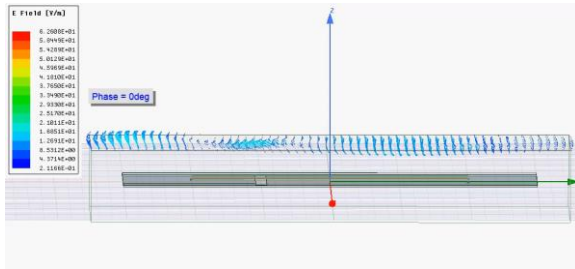

Example: Net Near Edge of Reference

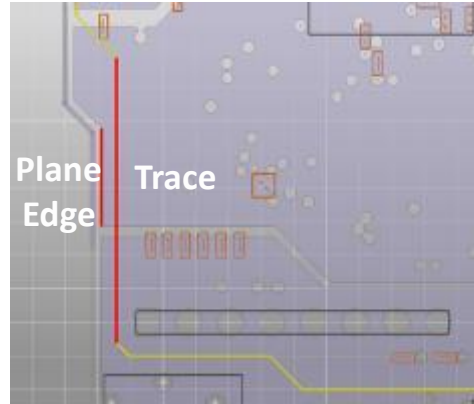

Wiring/ Crosstalk

- Critical Net Near I/O Net
- Exposed Critical Trace Length
- Critical Net Isolation
- Critical Differential Net Matching
- Wide Power/Ground Traces

Example: Via Stub Length



Example: Net to Net Coupling

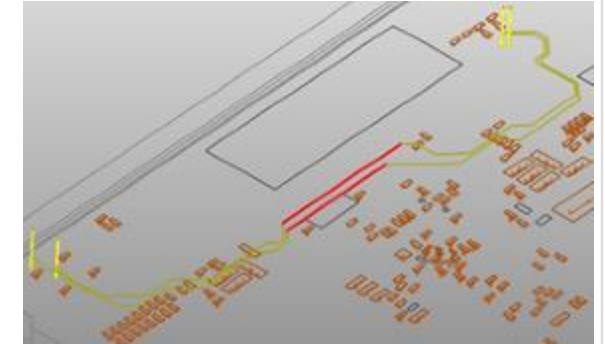

Decoupling

- Decoupling Capacitor Density
- Power Pin to Capacitor Distance
- IC Power/Ground Pin to Via Distance
- Decoupling Cap Distance to Via
- Power/Ground Trace Decoupling
- Power Via Density

Example: IC Power Pin to Via Distance

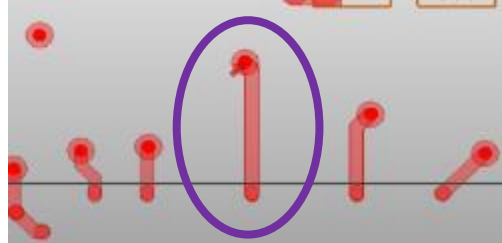

Example: Decoupling Capacitor Distance to Via

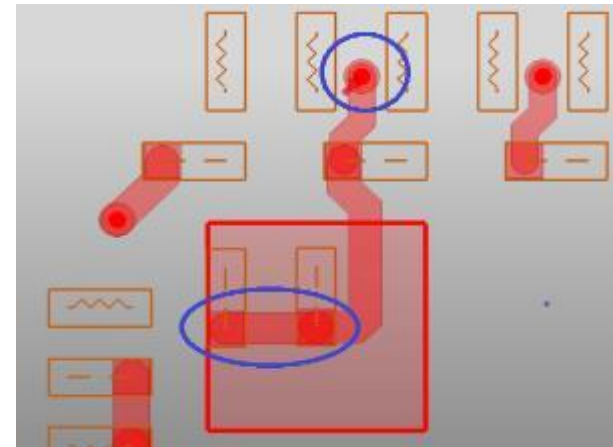

Summary

- Brief Overview of EM Techniques FEM and Transient
- Connector on Board “Assembly” Simulation
- HFSS 3D Components
- Thermal Simulation of EM Models
- EMI Analysis using HFSS
- EMI Scanner

